

INSTRUCTION MANUAL

ARBITRARY FUNCTION GENERATOR FGX-2220



■ About Brands and Trademarks

“TEXIO” is the product brand name of our industrial electronic devices.

All company names and product names mentioned in this manual are the trademark or the registered trademark of each company or group in each country and region.

■ About the Instruction Manual

Permission from the copyright holder is needed to reprint the contents of this manual, in whole or in part. Be aware that the product specifications and the contents of this manual are subject to change for the purpose of improvement.

For the purpose of considering the environment and reducing waste, we are progressively eliminating the paper or CD manuals attached to our products.

The latest version of the instruction manual is posted on our website.

(<https://www.texio.co.jp/>)

CONTENTS

USING THE PRODUCT SAFELY	I -IV
1 GETTING STARTED.....	1
1-2. Panel Overview.....	2
1-3. Setting Up the function Generator	6
2. QUICK REFERENCE.....	7
2-1. How to use the Digital Inputs.....	7
2-2. How to use the Help Menu	8
2-3. Selecting a Waveform	9
2-3-1. Square Wave.....	9
2-3-2. Ramp Wave.....	10
2-3-3. Sine Wave	10
2-4. Modulation.....	10
2-4-1. AM	10
2-4-2. FM	11
2-4-3. FSK Modulation	11
2-4-4. PM Modulation.....	12
2-4-5. SUM Modulation	13
2-5. Sweep	13
2-6. Burst	14
2-7. ARB.....	15
2-7-1. ARB-Add Built-In Waveform.....	15
2-7-2. ARB- Add Point.....	15
2-7-3. ARB- Add Line.....	15
2-7-4. ARB- Output Section.....	16
2-8. Utility Menu	16
2-8-1. Save	16
2-8-2. Recall.....	17
2-9. Frequency Counter	17
2-9-1. Frequency Counter	17
2-10. Coupling	17
2-10-1. Frequency Coupling.....	17
2-10-2. Amplitude Coupling.....	18
2-11. Tracking.....	18
2-12. Menu Tree	19
2-12-1. Waveform	19
2-12-2. ARB-Display	19
2-12-3. ARB-Edit.....	20
2-12-4. ARB- Built In	20
2-12-5. ARB-Save	21
2-12-6. ARB-Load	21
2-12-7. ARB-Output	22
2-12-8. MOD	22
2-12-9. SWEEP.....	23

2-12-10. SWEEP- More	23
2-12-11. Burst- N Cycle.....	24
2-12-12. Burst – Gate.....	24
2-12-13. UTIL.....	25
2-12-14. CH1/CH2	25
2-13. Default Settings	25
3. OPERATION	27
3-1. Select a Waveform	27
3-1-1. Sine Wave	27
3-1-2. Square Wave.....	27
3-1-3. Setting the Pulse Width	28
3-1-4. Setting a Ramp Waveform.....	30
3-1-5. Selecting a Noise Waveform.....	31
3-1-6. Setting the Frequency.....	32
3-1-7. Setting the Amplitude.....	33
3-1-8. Setting the DC Offset.....	34
4. MODULATION.....	35
4-1. Amplitude Modulation (AM)	35
4-1-1. Selecting AM Modulation	36
4-1-2. AM Carrier Shape	36
4-1-3. Carrier Frequency.....	37
4-1-4. Modulating Wave Shape.....	38
4-1-5. AM Frequency	39
4-1-6. Modulation Depth.....	40
4-1-7. Selecting the (AM) Modulation Source	41
4-2. Frequency Modulation (FM).....	42
4-2-1. Selecting Frequency Modulation (FM)	43
4-2-2. FM Carrier Shape	43
4-2-3. FM Carrier Frequency.....	43
4-2-4. FM Wave Shape	45
4-2-5. FM Frequency.....	46
4-2-6. Frequency Deviation.....	47
4-2-7. Selecting (FM) Modulation Source.....	48
4-3. Frequency Shift Keying (FSK) Modulation.....	49
4-3-1. Selecting FSK Modulation.....	50
4-3-2. FSK Carrier Shape	50
4-3-3. FSK Carrier Frequency.....	50
4-3-4. FSK Hop Frequency	51
4-3-5. FSK Rate	53
4-3-6. FSK Source	54
4-4. Phase Modulation (PM)	55
4-4-1. Selecting Phase Modulation (PM).....	55
4-4-2. PM Carrier Waveform	56
4-4-3. PM Carrier Frequency	56

4-4-4. PM Wave Shape.....	57
4-4-5. PM Frequency	58
4-4-6. Phase Deviation.....	59
4-4-7. Select the PM Source	60
4-5. SUM modulation	61
4-5-1. Selecting SUM modulation.....	61
4-5-2. SUM Carrier Waveform	62
4-5-3. SUM Carrier Frequency.....	62
4-5-4. SUM Waveform	63
4-5-5. Modulating Waveform Frequency.....	64
4-5-6. SUM Amplitude.....	65
4-5-7. Select the SUM Amplitude Source.....	66
4-6. Frequency Sweep	67
4-6-1. Selecting Sweep Mode	68
4-6-2. Setting Start and Stop Frequency.....	68
4-6-3. Center Frequency and Span.....	69
4-6-4. Sweep Mode.....	71
4-6-5. Sweep Time.....	72
4-6-6. Marker Frequency.....	73
4-6-7. Sweep Trigger Source	74
4-7. Burst Mode	75
4-7-1. Selecting Burst Mode.....	75
4-7-2. Burst Modes.....	76
4-7-3. Burst Frequency	76
4-7-4. Burst Cycle/Burst Count	77
4-7-5. Infinite Burst Count	79
4-7-6. Burst Period.....	79
4-7-7. Burst Phase	80
4-7-8. Burst Trigger Source.....	82
4-7-9. Burst Delay	83
4-7-10. Burst Trigger Output	84
5. SECONDARY SYSTEM FUNCTION SETTINGS	86
5-1. Save and Recall.....	86
5-2. System and Settings	89
5-2-1. Viewing and Updating the Firmware	89
5-2-2. Setting the Buzzer Sound	89
5-2-3. Frequency Counter.....	90
5-3. Dual channel Settings	91
5-3-1. Frequency Coupling.....	91
5-3-2. Amplitude Coupling.....	92
5-3-3. Tracking.....	93
6. CHANNEL SETTINGS	94
6-1. Output Impedance.....	94
6-2. Selecting the Output Phase	95

6-3. Synchronizing the Phase	96
6-4. DSO Link	96
7. ARBITRARY WAVEFORMS	98
7-1. Inserting Built-In Waveforms	98
7-1-1. Create an AbsAtan Waveform	98
7-1-2. Built-in Waveform	99
7-2. Display an Arbitrary Waveform	100
7-2-1. Set the Horizontal Display Range	100
7-2-2. Set the Vertical Display Properties	101
7-2-3. Page Navigation (Back Page).....	103
7-2-4. Page Navigation (Next Page)	104
7-2-5. Display	106
7-3. Editing an Arbitrary Waveform	106
7-3-1. Adding a Point to an Arbitrary Waveform.....	106
7-3-2. Adding a Line to an Arbitrary Waveform	108
7-3-3. Copy a Waveform	110
7-3-4. Clear the Waveform.....	111
7-3-5.ARB Protection	113
7-4.Ouput an Arbitrary Waveform	115
7-4-1. Ouput Arbitrary Waveform	115
7-5. Saving/Loading an Arbitrary Waveform	116
7-5-1. Saving a Waveform to Internal Memory.....	116
7-5-2. Saving a Waveform to USB flash disk	118
7-5-3. Load a Waveform from Internal Memory	120
7-5-4. Load a Waveform from USB	122
8. REMOTE INTERFACE	125
8-1. Establishing a Remote Connection	125
8-1-1. Configure USB interface	125
8-1-2. Remote control terminal connection	125
8-1-3. Command Syntax	126
8-2. Command List.....	130
8-3. System Commands	133
8-3-1. SYSTem:ERRor?.....	133
8-3-2. *IDN?	133
8-3-3. *RST	133
8-3-4. SYSTem:VERSion?	134
8-3-5. *OPC	134
8-3-6. *OPC?	135
8-4. Status Register Commands	135
8-4-1. *CLS	135
8-4-2. *ESE	135
8-4-3. *ESR?.....	136
8-4-4. *STB?	136

8-4-5. *SRE	137
8-5. System Remote Commands	137
8-5-1. SYSTem:LOCAl	137
8-5-2. SYSTem:REMOte	138
8-6. Apply Commands	138
8-6-1. SOURce[1 2]:APPLy:SINusoid	139
8-6-2. SOURce[1 2]:APPLy:SQUare	140
8-6-3. SOURce[1 2]:APPLy:RAMP	140
8-6-4. SOURce[1 2]:APPLy:PULSe	141
8-6-5. SOURce[1 2]:APPLy:NOISe	141
8-6-6. SOURce[1 2]:APPLy:USER	142
8-6-7. SOURce[1 2]:APPLy?	142
8-7. Output Commands	142
8-7-1. SOURce[1 2]:FUNCTion	143
8-7-2. SOURce[1 2]:FREQUency	144
8-7-3. SOURce[1 2]:AMPliTude	145
8-7-4. SOURce[1 2]:DCOffset	146
8-7-5. SOURce[1 2]:SQUare:DCYCLE	147
8-7-6. SOURce[1 2]:RAMP:SYMMetry	147
8-7-7. OUTPut[1 2]	148
8-7-8. OUTPut[1 2]:LOAD	149
8-7-9. SOURce[1 2]:VOLTagE:UNIT	149
8-8. Pulse Configuration Commands	150
8-8-1. SOURce[1 2]:PULSe:PERiod	150
8-8-2. SOURce[1 2]:PULSe:WIDTh	151
8-9. Amplitude Modulation (AM) Commands	152
8-9-1. AM Overview	152
8-9-2. SOURce[1 2]:AM:STATe	153
8-9-3. SOURce[1 2]:AM:SOURce	153
8-9-4. SOURce[1 2]:AM:INTernal:FUNCTion	154
8-9-5. SOURce[1 2]:AM:INTernal:FREQUency	154
8-9-6. SOURce[1 2]:AM:DEPTH	155
8-10. Frequency Modulation (FM) Commands	156
8-10-1. FM Overview	156
8-10-2. SOURce[1 2]:FM:STATe	156
8-10-3. SOURce[1 2]:FM:SOURce	157
8-10-4. SOURce[1 2]:FM:INTernal:FUNCTion	157
8-10-5. SOURce[1 2]:FM:INTernal:FREQUency	158
8-10-6. SOURce[1 2]:FM:DEVIation	159
8-11. Frequency-Shift Keying (FSK) Commands	160
8-11-1. FSK Overview	160
8-11-2. SOURce[1 2]:FSKey:STATe	160
8-11-3. SOURce[1 2]:FSKey:SOURce	161
8-11-4. SOURce[1 2]:FSKey:FREQUency	161

8-11-5. SOURce[1 2]:FSKey:INTErnal:RATE	162
8-12. Phase Modulation (PM) Commands	163
8-12-1. PM Overview	163
8-12-2. SOURce[1 2]:PM:STATe	163
8-12-3. SOURce[1 2]:PM:SOURce	164
8-12-4. SOURce[1 2]:PM:INTErnal:FUNctIon	164
8-12-5. SOURce[1 2]:PM:INTErnal:FREQuency	165
8-12-6. SOURce[1 2]:PM:DEVIation	166
8-13. SUM Modulation (SUM) Commands	167
8-13-1. SUM Overview	167
8-13-2. SOURce[1 2]:SUM:STATe	167
8-13-3. SOURce[1 2]:SUM:SOURce	168
8-13-4. SOURce[1 2]:SUM:INTErnal:FUNctIon	168
8-13-5. SOURce[1 2]:SUM:INTErnal:FREQuency	169
8-13-6. SOURce[1 2]:SUM:AMPL	169
8-14. Frequency Sweep Commands	171
8-14-1. Sweep Overview	171
8-14-2. SOURce[1 2]:SWEep:STATe	172
8-14-3. SOURce[1 2]:FREQuency:START	172
8-14-4. SOURce[1 2]:FREQuency:STOP	173
8-14-5. SOURce[1 2]:FREQuency:CENTEr	173
8-14-6. SOURce[1 2]:FREQuency:SPAN	174
8-14-7. SOURce[1 2]:SWEep:SPACIng	175
8-14-8. SOURce[1 2]:SWEep:TIME	175
8-14-9. SOURce[1 2]:SWEep:SOURce	176
8-14-10. SOURce[1 2]:MARKer:FREQuency	177
8-14-11. SOURce[1 2]:MARKer	177
8-15. Burst Mode Commands	178
8-15-1. Burst Mode Overview	178
8-15-2. SOURce[1 2]:BURSt:STATe	179
8-15-3. SOURce[1 2]:BURSt:MODE	180
8-15-4. SOURce[1 2]:BURSt:NCYCles	180
8-15-5. SOURce[1 2]:BURSt:INTErnal:PERiod	181
8-15-6. SOURce[1 2]:BURSt:PHASe	182
8-15-7. SOURce[1 2]:BURSt:TRIGger:SOURce	183
8-15-8. SOURce[1 2]:BURSt:TRIGger:DELay	184
8-15-9. SOURce[1 2]:BURSt:TRIGger:SLOPe	184
8-15-10. SOURce[1 2]:BURSt:GATE:POLarity	185
8-15-11. SOURce[1 2]:BURSt:OUTPut:TRIGger:SLOPe	185
8-15-12. OUTPut[1 2]:TRIGger	186
8-15-13. SOURce[1 2]:BURSt:TRIGger:MANual	187
8-16. Arbitrary Waveform Commands	187
8-16-1. Arbitrary Waveform Overview	187
8-16-2. SOURce[1 2]:FUNctIon USER	188
8-16-3. SOURce[1 2]:DATA:DAC	188

8-16-4. SOURce[1 2]:ARB:EDIT:COpy	189
8-16-5. SOURce[1 2]:ARB:EDIT:DELeTe	189
8-16-4. SOURce[1 2]:ARB:EDIT:DELeTe:ALL	190
8-16-7. SOURce[1 2]:ARB:EDIT:POINt	190
8-16-8. SOURce[1 2]:ARB:EDIT:LINE	190
8-16-9. SOURce[1 2]:ARB:EDIT:PROTeCt	191
8-16-10. SOURce[1 2]:ARB:EDIT:PROTeCt:ALL	191
8-16-11. SOURce[1 2]:ARB:EDIT:UNProtect.....	191
8-16-12. SOURce[1 2]:ARB:OUTPut	191
8-17. COUNTER Commands	192
8-17-1. COUNTER:STATE	192
8-17-2. COUNter:GATe.....	192
8-17-3. COUNter:VALue?	193
8-18. PHASE Commands	193
8-18-1. SOURce[1 2]:PHASe.....	193
8-18-2. SOURce[1 2]:PHASe:SYNChronize	194
8-19. COUPLE Commands	194
8-19-1.SOURce[1 2]:FREQuency:COUPle:MODE	194
8-19-2. SOURce[1 2]:FREQuency:COUPle:OFFSet.....	194
8-19-3. SOURce[1 2]:FREQuency:COUPle:RATio	195
8-19-4. SOURce[1 2]:AMPlitude:COUPle:STATe	195
8-19-5. SOURce[1 2]:TRACk	196
8-20. Save and Recall Commands	196
8-20-1. *SAV	197
8-20-2. *RCL	197
8-20-3. MEMory:STATe:DELeTe	197
8-20-4. MEMory:STATe:DELeTe ALL.....	197
8-21. Error Messages.....	198
8-21-1.Command Error Codes.....	198
8-21-2.Execution Errors	199
8-21-3.Query Errors	204
8-21-4.Arbitrary Waveform Errors	204
8-22. SCPI Status Register	205
8-22-1. Register types.....	205
8-22-2. FGX-2220 Status System	206
8-22-3. Questionable Status Register	207
8-22-4. Standard Event Status Registers.....	207
8-22-5. The Status Byte Register	208
8-22-6. Output Queue	209
8-22-7. Error Queue	209
9. APPDENIX	210
9-1. FGX-2220 Specifications	210
9-2. External Dimensions Figure	214
9-3. Usage Notes for FGX-2220	215



USING THE PRODUCT SAFELY

■ Preface

To use the product safely, read instruction manual to the end. Before using this product, understand how to correctly use it. If you read the manuals but you do not understand how to use it, ask us or your local dealer. After you read the manuals, save it so that you can read it anytime as required.

■ Pictorial indication

The manuals and product show the warning and caution items required to safely use the product. The following pictorial indication is provided.

Pictorial indication	
	Some part of this product or the manuals may show this pictorial indication. In this case, if the product is incorrectly used in that part, a serious danger may be brought about on the user's body or the product. To use the part with this pictorial indication, be sure to refer to the manuals.
 	If you use the product, ignoring this indication, you may get killed or seriously injured. This indication shows that the warning item to avoid the danger is provided. If you incorrectly use the product, ignoring this indication, you may get slightly injured or the product may be damaged. This indication shows that the caution item to avoid the danger is provided.

Please be informed that we are not responsible for any damages to the user or to the third person, arising from malfunctions or other failures due to wrong use of the product or incorrect operation, except such responsibility for damages as required by law.

USING THE PRODUCT SAFELY



■ Do not remove the product's covers and panels

Never remove the product's covers and panels for any purpose. Otherwise, the user's electric shock or fire may be incurred.

■ Warning on using the product

Warning items given below are to avoid danger to user's body and life and avoid the damage or deterioration of the product. Use the product, observing the following warning and caution items.

■ Warning items on power supply

● Power supply voltage

The rated power supply voltages of the product are 100, 120, 220 and 240VAC. The rated power supply voltage for each product should be confirmed by reading the label attached on the back of the product or by the "rated" column shown in the instruction manual. The specification of power cord attached to the products is rated to 125VAC for all products which are designed to be used in the areas where commercial power supply voltage is not higher than 125VAC. Accordingly, you must change the power cord if you want to use the product at the power supply voltage higher than 125VAC. If you use the product without changing power cord to 250VAC rated one, electric shock or fire may be caused. When you used the product equipped with power supply voltage switching system, please refer to the corresponding chapter in the instruction manuals of each product.

● Power cord

(IMPORTANT) The attached power cord set can be used for this device only.

If the attached power cord is damaged, stop using the product and call us or your local dealer. If the power cord is used without the damage being removed, an electric shock or fire may be caused.

● Protective fuse

If an input protective fuse is blown, the product does not operate. For a product with external fuse holder, the fuse may be replaced. As for how to replace the fuse, refer to the corresponding chapter in the instruction manual. If no fuse replacement procedures are indicated, the user is not permitted to replace it. In such case, keep the case closed and consult us or your local dealer. If the fuse is incorrectly replaced, a fire may occur.

USING THE PRODUCT SAFELY

■ Warning item on Grounding

If the product has the GND terminal on the front or rear panel surface, be sure to ground the product to safely use it.

■ Warnings on Installation environment

● Operating temperature and humidity

Use the product within the operating temperature indicated in the “rating” temperature column. If the product is used with the vents of the product blocked or in high ambient temperatures, a fire may occur. Use the product within the operating humidity indicated in the “rating” humidity column. Watch out for condensation by a sharp humidity change such as transfer to a room with a different humidity. Also, do not operate the product with wet hands. Otherwise, an electric shock or fire may occur.

● Use in gas

Use in and around a place where an inflammable or explosive gas or steam is generated or stored may result in an explosion and fire. Do not operate the product in such an environment. Also, use in and around a place where a corrosive gas is generated or spreading causes a serious damage to the product. Do not operate the product in such an environment.

● Installation place

Do not insert metal and inflammable materials into the product from its vent and spill water on it. Otherwise, electric shock or fire may occur.

■ Do not let foreign matter in

Do not insert metal and inflammable materials into the product from its vent and spill water on it. Otherwise, electric shock or fire may occur.

■ Warning item on abnormality while in use

If smoke or fire is generated from the product while in use, stop using the product, turn off the switch, and remove the power cord plug from the outlet. After confirming that no other devices catch fire, ask us or your local dealer.

USING THE PRODUCT SAFELY

■ Input / Output terminals

Maximum input to terminal is specified to prevent the product from being damaged. Do not supply input, exceeding the specifications that are indicated in the "Rating" column in the instruction manual of the product. Also, do not supply power to the output terminals from the outside. Otherwise, a product failure is caused.

■ Calibration

Although the performance and specifications of the product are checked under strict quality control during shipment from the factory, they may be deviated more or less by deterioration of parts due to their aging or others.

It is recommended to periodically calibrate the product so that it is used with its performance and specifications stable. For consultation about the product calibration, ask us or your local dealer.

■ Daily Maintenance

When you clean off the dirt of the product covers, panels, and knobs, avoid solvents such as thinner and benzene. Otherwise, the paint may peel off or resin surface may be affected. To wipe off the covers, panels, and knobs, use a soft cloth with neutral detergent in it.

During cleaning, be careful that water, detergents, or other foreign matters do not get into the product.

If a liquid or metal gets into the product, an electric shock and fire are caused.

During cleaning, remove the power cord plug from the outlet.

Use the product correctly and safely, observing the above warning and caution items. Because the instruction manual indicates caution items even in individual items, observe those caution items to correctly use the product.

If you have questions or comments about the manuals, ask us or E-Mail us.

1 GETTING STARTED

The Getting started chapter introduces the function generator's main features, appearance, set up procedure and power-up.

1-1. Main Features

Model name	Frequency bandwidth
FGX-2220	1 μ Hz~20MHz
Performance	<ul style="list-style-type: none">• DDS Function Generator series• 1μHz high frequency resolution maintained at full range• 20ppm frequency stability• Arbitrary Waveform Capability<ul style="list-style-type: none">120 MSa/s sample rate60 MSa/s repetition rate4k-point waveform length10 groups of 4k waveform memoriesTrue waveform output to displayUser-defined output sectionDWR (Direct Waveform Reconstruction) capabilityWaveform editing via PC
Features	<ul style="list-style-type: none">• Sine, Square, Ramp, Pulse, Noise, standard waveforms• Internal and external LIN/LOG sweep with marker output• Int/Ext AM, FM, PM, FSK, SUM modulation• Burst function with internal and external triggers without marker output• Store/recall 10 groups of setting memories• Output overload protection
Interface	<ul style="list-style-type: none">• USB interface as standard• 3.5 inch Color TFT LCD (320 X 240) graphical user interface• AWES (Arbitrary Waveform Editing Software) PC software

1-2. Panel Overview

Front Panel

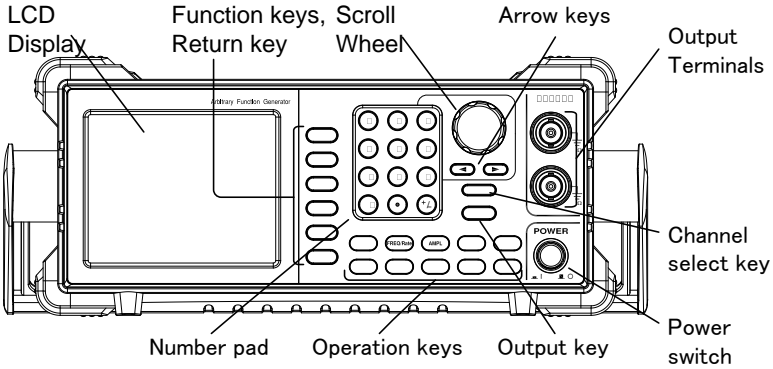

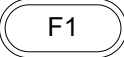

LCD Display TFT color display, 320 x 240 resolution.

Function Keys F1~F5  Activates functions which appear on the right-hand side of the LCD display.

Return Key  Goes back to the previous menu level.

Operation Keys  The waveform key is used to select a type of waveform.







 The FREQ/Rate key is used to set the frequency or sample rate.

 AMPL sets the waveform amplitude.

 Sets the DC offset.

 The UTIL key is used to access the save and recall options, update and view the firmware version, access the calibration options, output impedance settings and frequency meter.

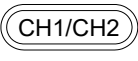
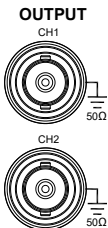
 ARB is used to set the arbitrary waveform parameters.

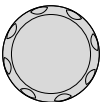
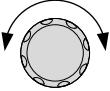
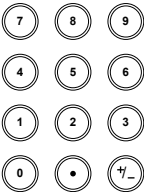
	  	The MOD, Sweep and Burst keys are used to set the modulation, sweep and burst settings and parameters.
Preset Key		The preset key is used to recall a preset state.
Output Key		The Output key is used to turn on or off the waveform output.
Channel Select Key		The channel select key is used to switch between the two output channels.
Output ports		CH1: Channel 1 output port CH2: Channel 2 output port
Power Button		Turns the power on or off.
Arrow Keys		Used to select digits when editing parameters.
Scroll Wheel	 	The scroll wheel is used to edit values and parameters. Decrease Increase
Keypad		The digital keypad is used to enter values and parameters. The keypad is often used in conjunction with the arrow keys and variable knob.

Rear Panel

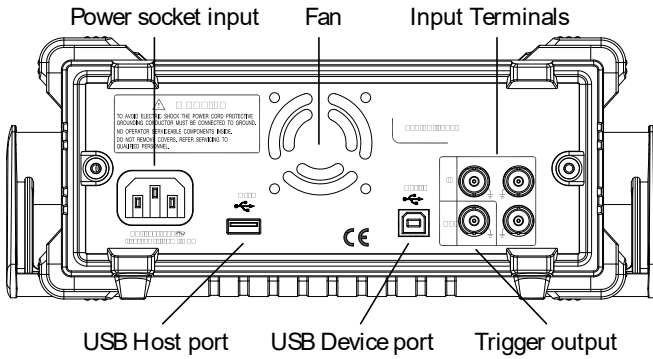

Trigger Input

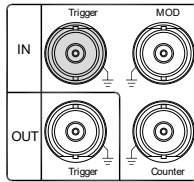

External trigger input. Used to receive external trigger signals.

Trigger Output

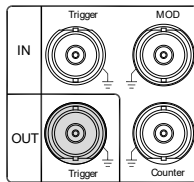

Marker output signal. Used for Sweep and ARB mode only.

Fan

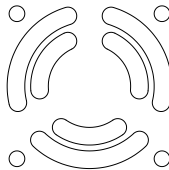

Fan.

Power Input Socket

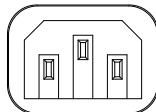

AC 100-240V~
50-60Hz 25W MAX

Power input: 100~240V AC
50~60Hz.

USB Host



USB type-A host port.

USB Device Port

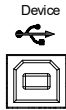

USB type-B device port is used to connect the function generator to a PC for remote control.

Counter Input

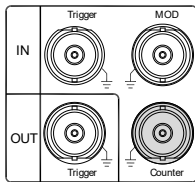

Frequency counter input.

MOD Input

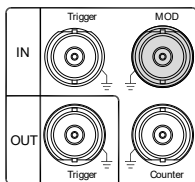

Modulation input terminal.

Display

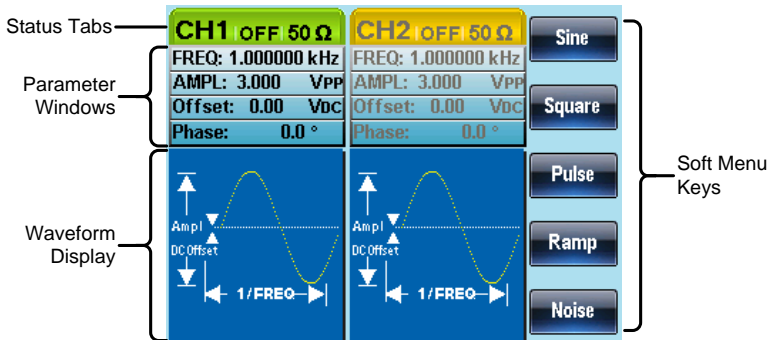

Parameter Windows The Parameter display and edit window.

Status Tabs Displays the current channel and setting status.

Waveform Display Used to display the waveform

Soft Menu Keys The function keys (F1~F5) beside the Soft Menu keys correspond to the soft keys.

1-3. Setting Up the function Generator

Background This section describes how to adjust the handle and power up the function generator.

Adjusting the Handle Pull out the handle sideways and rotate it.

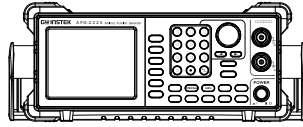

Place the FGX-2220 horizontally,

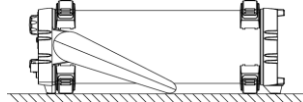

Or tilt the stand.

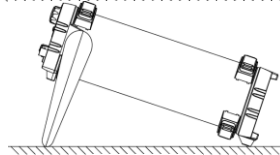

Place the handle vertically to hand carry.

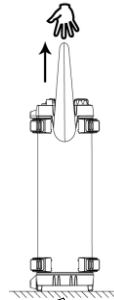

Power Up

1. Connect the power cord to the socket on the rear panel.

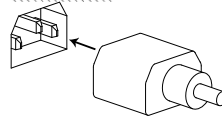

2. Turn on the power switch on the front panel.



3. When the power switch is turned on the screen displays the loading screen.

The function generator is now ready to be used.

2. QUICK REFERENCE

This chapter describes the operation shortcuts, built-in help and factory default settings. This chapter is to be used as a quick reference, for detailed explanations on parameters, settings and limitations, please see the operation chapters

2-1. How to use the Digital Inputs

Background

The FGX-2220 has three main types of digital inputs: the number pad, arrow keys and scroll wheel. The following instructions will show you how to use the digital inputs to edit parameters.

1. To select a menu item, press the corresponding function keys below (F1–F5). For example the function key F1 corresponds to the Soft key “Sine”.



2. To edit a digital value, use the arrow keys to move the cursor to the digit that needs to be edited.



CH1	ON	50Ω	CH2	ON	50Ω
FREQ:	1.000000kHz		FREQ:	1.000000kHz	
AMPL:	3.00Vpp		AMPL:	3.00Vpp	
Offset:	0.00Vdc		Offset:	0.00Vdc	
Phase:	0.0°		Phase:	0.0°	

3. Use the scroll wheel to edit the parameter. Clockwise increases the value, counter clockwise decreases the value.

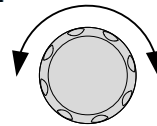

4. Alternatively, the number pad can be used to set the value of a highlighted parameter.

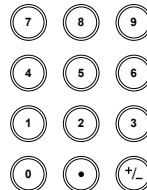

2-2. How to use the Help Menu

Background

Every key and function has a detailed description in the help menu.

1. Press UTIL
2. Press System (F3)
3. Press Help (F2)

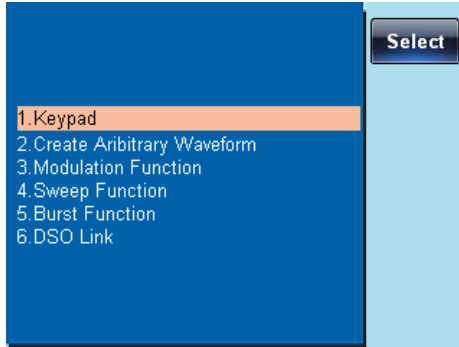
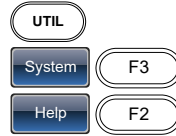

4. Use the scroll wheel to navigate to a help item. Press Select to choose the item.

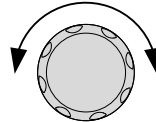

Keypad	Provides help on any front panel key that is pressed.
Create Arbitrary Waveform	Provides help on creating arbitrary waveforms.
Modulation Function	Explains how to create Modulated waveforms.
Sweep Function	Provides help on the Sweep function.
Burst Function	Provides help on the Burst function.
DSO Link	Provides help on DSO link.

5. For example, select item 4 to see help on the sweep functions.

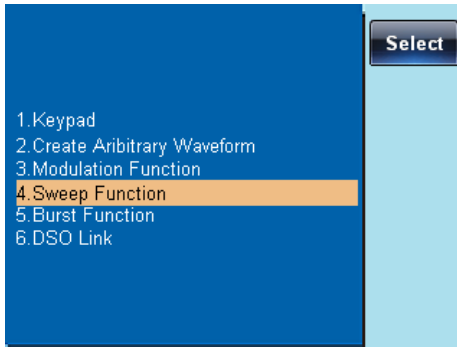

6. Use the scroll wheel to navigate the help information.

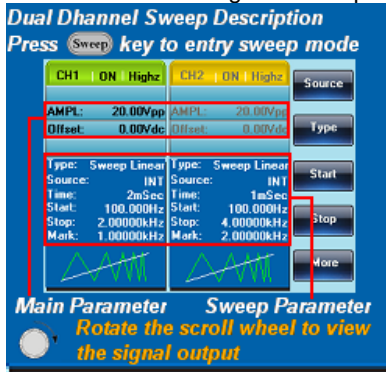

7. Press Return to return to the previous menu.



2-3. Selecting a Waveform

2-3-1. Square Wave

Example: Square wave, 3Vpp, 75% duty cycle, 1kHz.

Output:

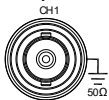

Input: N/A

1. Press Waveform and select Square (F2).



2. Press Duty (F1), 7 + 5 + % (F2).



3. Press Freq/Rate, 1 + kHz (F4).



4. Press AMPL followed by, 3 + VPP (F5).



5. Press the Output key.





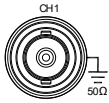

2-3-2. Ramp Wave

Example: Ramp Wave, 5Vpp, 10kHz, 50% Symmetry.

Output:



Input: N/A

1. Press the Waveform key, and select Ramp (F4).

2. Press SYM(F1), 5 + 0 +%(F2).

3. Press the Freq/Rate key then 1 + 0 + kHz (F4).

4. Press the AMPL key then 5 +VPP (F5).

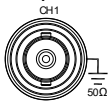
5. Press the Output key.





2-3-3. Sine Wave

Example: Sine Wave, 10Vpp,100kHz

Output:

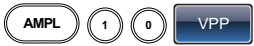

Input: N/A

1. Press the Waveform key and select Sine (F1).

2. Press the Freq/Rate key, followed by 1 + 0 +0 + kHz (F4).

3. Press the AMPL key, followed by 1 + 0 +VPP (F5).

4. Press the output key.

2-4. Modulation

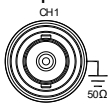





2-4-1. AM





Example: AM modulation. 100Hz modulating square wave. 1kHz Sine wave carrier. 80% modulation depth.

Output:



Input: N/A

1. Press the MOD key and select AM (F1).

2. Press Waveform and select Sine (F1).

3. Press the Freq/Rate key, followed by 1 + kHz (F4).

4. Press the MOD key, select AM (F1), Shape (F4), Square (F2).

5. Press the MOD key, select AM (F1), AM Freq (F3).

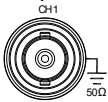
6. Press 1 + 0 + 0 + Hz (F2).

7. Press the MOD key, select AM (F1), Depth (F2). 
8. Press 8 + 0 + % (F1). 
9. Press MOD, AM (F1), Source (F1), INT (F1). 
10. Press the output key. 











2-4-2. FM

Example: FM modulation. 100Hz modulating square wave. 1kHz Sine wave carrier. 100 Hz frequency deviation. Internal Source.

Output:



Input: N/A



1. Press the MOD key and select FM (F2). 
2. Press Waveform and select Sine (F1). 
3. Press the Freq/Rate key, followed by 1 + kHz (F4). 
4. Press the MOD key, select FM (F2), Shape (F4), Square (F2). 
5. Press the MOD key, select FM (F2), FM Freq (F3). 
6. Press 1 + 0 + 0 + Hz (F2). 
7. Press the MOD key, select FM (F2), Freq Dev (F2). 
8. Press 1 + 0 + 0 + Hz (F3). 
9. Press MOD, FM (F2), Source (F1), INT (F1). 
10. Press the Output key. 

2-4-3. FSK Modulation

Example: FSK modulation. 100Hz Hop frequency. 1kHz Carrier wave. Sine wave. 10 Hz Rate. Internal Source.

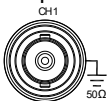
Output:



1. Press the MOD key and select FSK (F3). 
2. Press Waveform and select Sine (F1). 

Input: N/A

3. Press the Freq/Rate key, followed by 1 + kHz (F4).



4. Press the MOD key, select FSK (F3), FSK Rate (F3).



5. Press 1 + 0 + Hz (F2).



6. Press the MOD key, select FSK (F3), Hop Freq (F2).



7. Press 1 + 0 + 0 + Hz (F3).



8. Press MOD, FSK (F3), Source (F1), INT (F1).



9. Press the output key.



2-4-4. PM Modulation

Example: PM modulation. 800Hz sinusoidal carrier wave. 15 kHz modulating sine wave. 50° phase deviation. Internal Source.

Output:

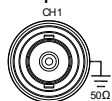

Input: N/A

1. Press Waveform and select Sine (F1).



2. Press the MOD key and select PM (F4).



3. Press the Freq/Rate key, followed by 8 + 0 + 0 + Hz (F3).



4. Press the MOD key, select PM (F4), Shape (F4), Sine (F1).



5. Press MOD, then PM (F4), PM Freq (F3).



6. Press 1 + 5 + kHz (F3).



7. Press MOD, PM (F4), PM Dev (F2).



8. Press 5 + 0 + Degree (F1).



9. Press MOD, PM (F4), Source (F1), INT (F1).



10. Press the Output key.









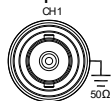





















2-4-5. SUM Modulation

Example: SUM modulation. 100Hz modulating square wave, 1kHz sinusoidal carrier wave, 50% SUM amplitude, internal source.

Output:



Input: N/A

1. Press the MOD key, then SUM (F5).  
2. Press Waveform, and select Sine (F1).  
3. Press Freq/Rate followed by 1 + kHz (F4).   
4. Press the MOD key, SUM (F5), Shape (F4), Square (F2).   

5. Press the MOD key and select SUM (F5), SUM Freq (F3).   
6. Press 1 + 0 + 0 + Hz (F2).    
7. Press the MOD key and select SUM (F5), SUM Ampl (F2).   
8. Press 5 + 0 + % (F1).   
9. Press MOD, SUM (F5), Source (F1), INT (F1).   

10. Press the Output key. 

2-5. Sweep

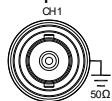
Example: Frequency Sweep. Start Frequency 10mHz, Stop frequency 1MHz. Log sweep, 1 second sweep, Marker Frequency 550 Hz, Manual Trigger.

Output:



Input: N/A

1. Press Sweep, Start (F3).  
2. Press 1 + 0 + mHz (F2).   
3. Press Sweep, Stop (F4).  
4. Press 1 + MHz (F5).  
5. Press Sweep, Type (F2), Log (F2).   
6. Press Sweep, More (F5), SWP Time (F1).   
7. Press 1 + SEC (F2).  

8. Press Sweep, More (F5), Marker (F4), ON/OFF (F2), Freq (F1).



9. Press 5 + 5 + 0 + Hz (F3).



10. Press the Output key.



11. Press Sweep, Source (F1), Manual (F3), Trigger (F1).



2-6. Burst

Example: Burst Mode, N-Cycle (Internally triggered), 1kHz burst frequency, Burst count = 5, 10 ms Burst period, 0° burst phase, Internal trigger, 10 us delay, rising edge trigger out

Output:

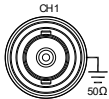

Input: N/A

1. Press FREQ/Rate 1 kHz (F4).

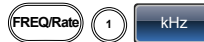

2. Press Burst, N Cycle (F1), Cycles (F1).



3. Press 5 + Cyc (F2).



4. Press Burst, N Cycle (F1), Period (F4).



5. Press 1 + 0 + msec (F2).



6. Press Burst, N Cycle (F1), Phase (F3).



7. Press 0 + Degree (F2).



8. Press Burst, N Cycle (F1), TRIG set (F5), INT (F1).



9. Press Burst, N Cycle (F1), TRIG set (F5), Delay (F4).



10. Press 1 + 0 + uSEC (F2).



11. Press Burst, N Cycle (F1), TRIG set (F5), TRIG out (F5), ON/OFF (F3), Rise (F1).



12. Press the Output key.



2-7. ARB

2-7-1. ARB–Add Built-In Waveform

Example: ARB Mode, Exponential Rise. Start 0, Length 100, Scale 327.

Output:

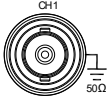

1. Press ARB, Built in (F3), Wave (F4), Math(F2), use the scroll wheel to select Exporise and then press Select(F5).



2. Press Start (F1), 0 + Enter (F2), Return.



3. Press Length (F2), 100, Enter (F2), Return.

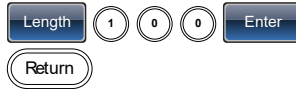

4. Press Scale (F3), 327, Enter (F2), Return, Done (F5).



2-7-2. ARB- Add Point

Example: ARB Mode, Add point, Address 40, data 300.

Output:

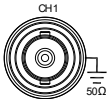

1. Press ARB, Edit (F2), Point (F1), Address (F1)



2. Press 4 + 0 + Enter (F2), Return



3. Press Data (F2), 3+0+0, Enter (F2).



2-7-3. ARB- Add Line

Example: ARB Mode, Add line, Address:Data (10:30, 50:100)

Output:

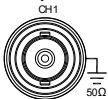

1. Press ARB, Edit (F2), Line (F2), Start ADD (F1).



2. Press 1 + 0 + Enter (F2), Return.



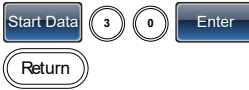
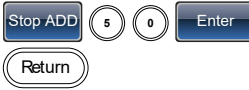
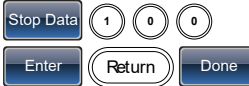



3. Press Start Data (F2), 3 + 0, Enter (F2), Return.
 
4. Press Stop ADD (F3), 5 + 0, Enter (F2), Return.
 
5. Press Stop Data (F4), 1 + 0 + 0, Enter (F2), Return, Done (F5).
 

2-7-4. ARB– Output Section

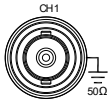
Example: ARB Mode, Output ARB Waveform, Start 0, Length 1000.

Output:

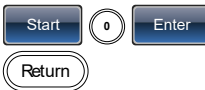



1. Press ARB, Output (F4).
 
2. Press Start (F1), 0 + Enter (F2), Return.
 
3. Press Length (F2), 1 + 0 + 0, Enter (F2), Return.
 

2-8. Utility Menu

2-8-1. Save

Example: Save to Memory file #5.

1. Press UTIL, Memory (F1), Store (F1).
 
2. Choose a setting using the scroll wheel and press Done (F5).
 

2-8-2. Recall

Example: Recall Memory file #5.

1. Press UTIL, Memory (F1), Recall (F2).



2. Choose a setting using the scroll wheel and press Done (F5).

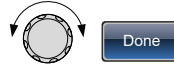

2-9. Frequency Counter

2-9-1. Frequency Counter

Example: Turn on the frequency counter. Gate time: 1 second.

Output: N/A

1. Press UTIL, Counter (F5).



Input:

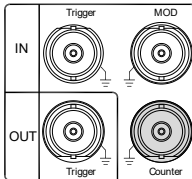

2. Press Gate Time (F1), and press 1 Sec (F3) to choose a gate time of 1 second.



3. Connect the signal of interest to the Frequency counter input on the rear panel.

2-10. Coupling

2-10-1. Frequency Coupling

Example: Frequency Coupling

1. Press UTIL, Dual Chan (F4) to enter the coupling function.



2. Press Freq Cpl (F1) to select the frequency coupling function.



3. Press Offset (F2). The offset is the frequency difference between CH1 and CH2. Use the number keys or scroll wheel to enter the offset.



2-10-2. Amplitude Coupling

Example: Amplitude Coupling

1. Press UTIL, Dual Chan (F4) to enter the coupling function.



2. Press Ampl Cpl (F2), ON (F1) to select the amplitude coupling function.



3. Couples the amplitude and offset between both channels. Any changes in amplitude in the current channel are reflected in the other channel.

2-11. Tracking

Example: Tracking

1. Press UTIL, Dual Chan (F4) to enter the coupling function.



2. Press Tracking (F3), ON (F2) to turn on the tracking function.



3. When tracking is turned on, parameters such as amplitude and frequency from the current channel are mirrored on the other channel.

2-12. Menu Tree

Conventions

Use the menu trees as a handy reference for the function generator functions and properties. The FGX-2220 menu system is arranged in a hierarchical tree. Each hierarchical level can be navigated with the operation or soft menu keys. Pressing the Return key will return you to the previous menu level.

2-12-1. Waveform

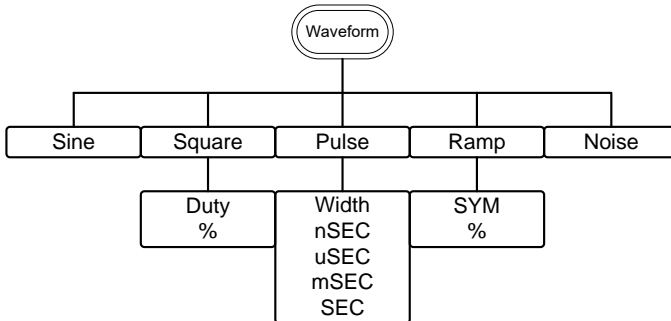

2-12-2. ARB-Display

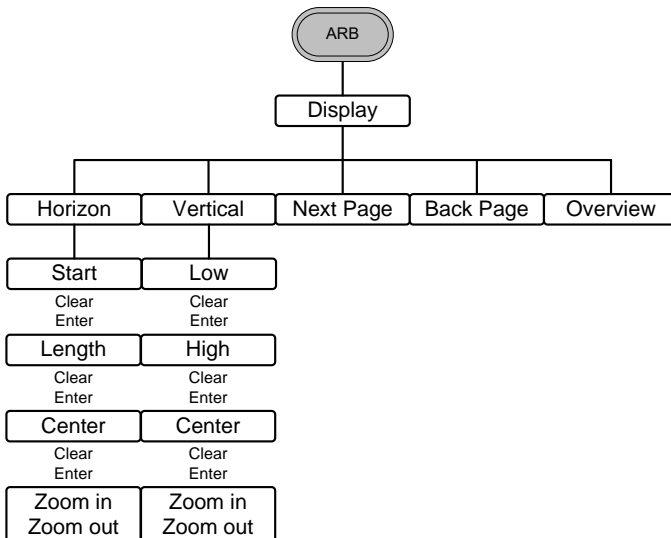

2-12-3. ARB-Edit

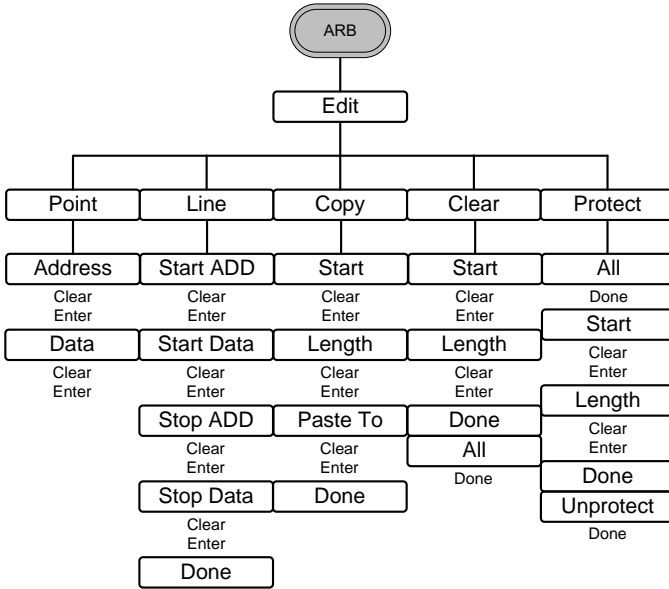

2-12-4. ARB- Built In

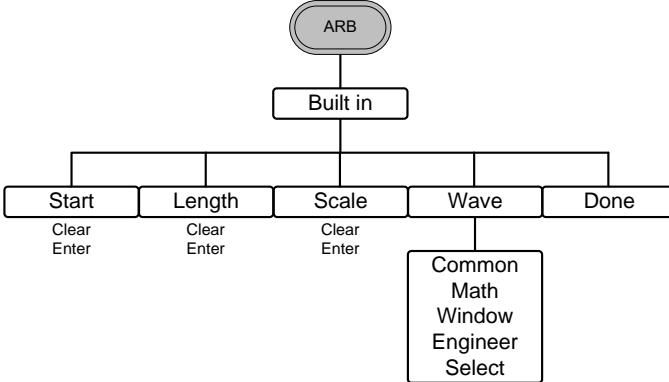

2-12-5. ARB-Save

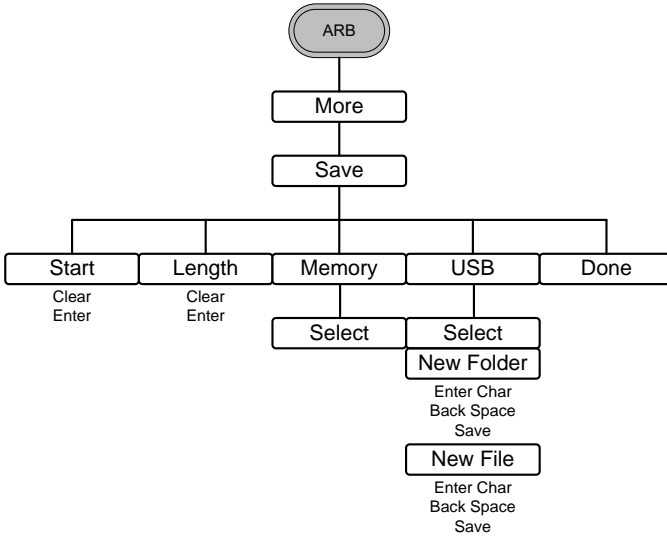

2-12-6. ARB-Load

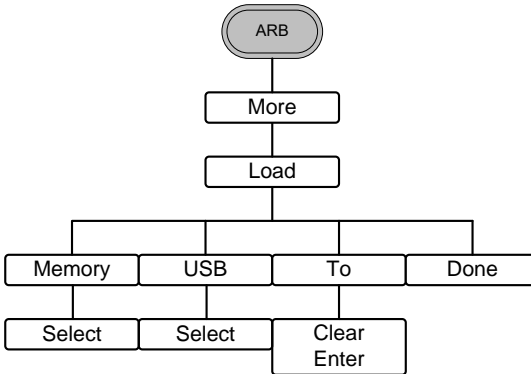

2-12-7. ARB-Output

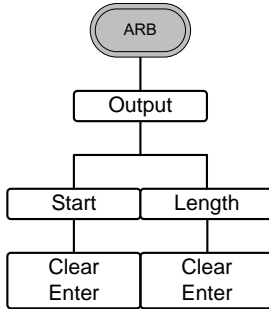

2-12-8. MOD

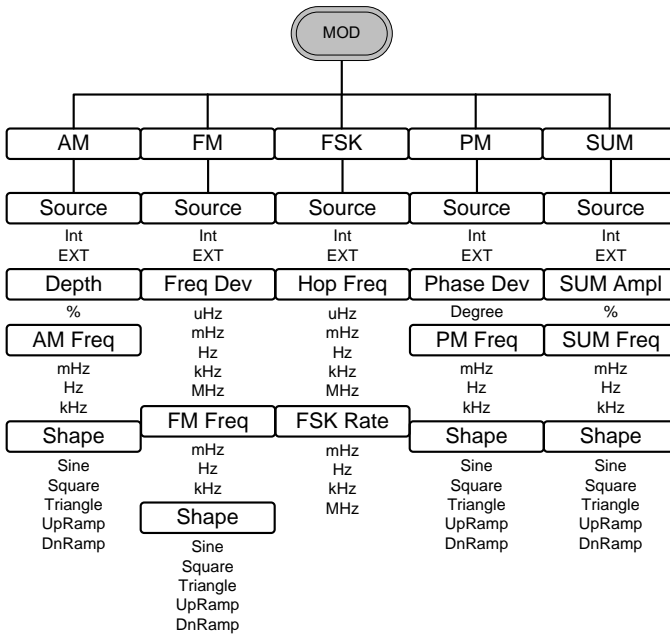

2-12-9. SWEEP

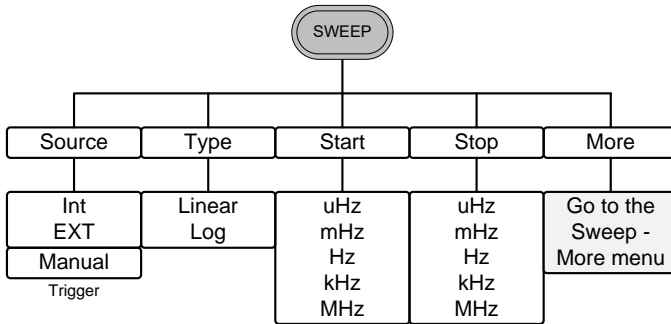

2-12-10. SWEEP- More

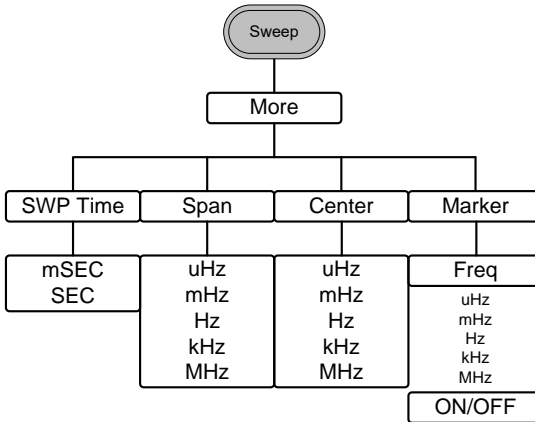

2-12-11. Burst- N Cycle

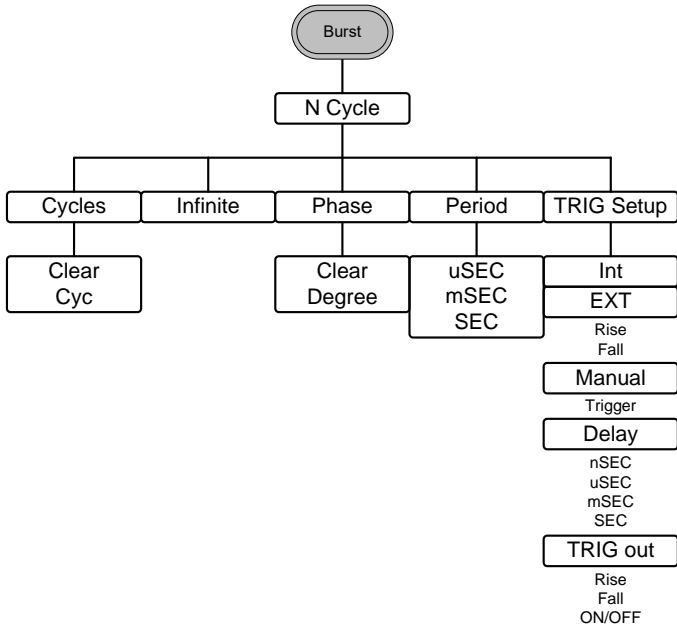

2-12-12. Burst – Gate

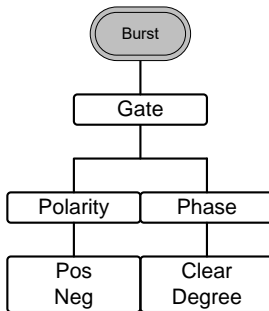

2-12-13. UTIL

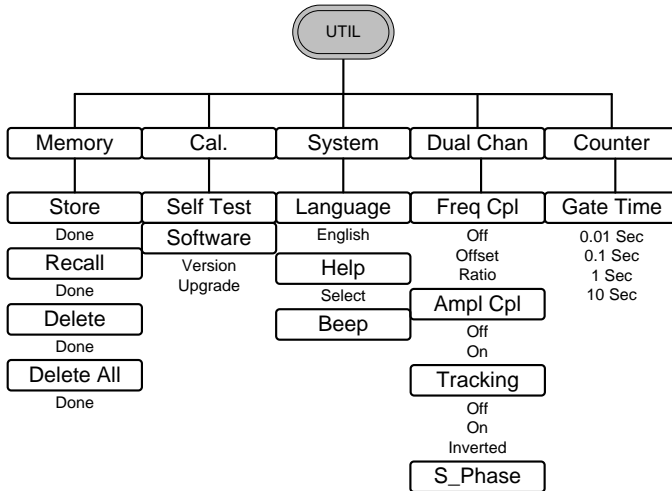

2-12-14. CH1/CH2

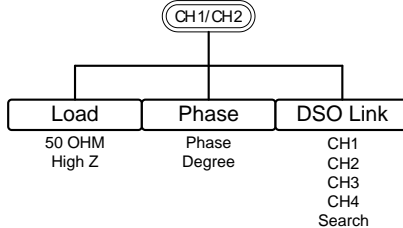

2-13. Default Settings

The Preset key is used to restore the default panel settings.



Output Settings	Function	Sine Wave
	Frequency	1kHz
	Amplitude	3.000 Vpp
	Offset	0.00V dc
	Output units	Vpp
	Output terminal	50Ω

Modulation	Carrier wave	1kHz sine wave
	Modulation wave	100Hz sine wave
	AM depth	100%
	FM deviation	100Hz
	FSK hop frequency	100Hz
	FSK frequency	10Hz
	PM phase deviation	180°
	SUM amplitude	50%
	Modem status	Off
Sweep	Start/Stop frequency	100Hz/1kHz
	Sweep time	1s
	Sweep type	Linear
	Sweep status	Off
Burst	Burst frequency	1kHz
	Ncycle	1
	Burst period	10ms
	Burst starting phase	0°
	Burst status	Off
System Settings	Power off signal	On
	Display mode	On
	Error queue	Cleared
	Memory settings	No change
	Output	Off
Trigger	Trigger source	Internal (immediate)
Calibration	Calibration Menu	Restricted

3. OPERATION

The Operation chapter shows how to output basic waveform functions. For details on modulation, sweep, burst and arbitrary waveforms, please see the Modulation and Arbitrary waveform chapters on pages 35 and 98.

3-1. Select a Waveform

The FGX-2220 can output 5 standard waveforms: sine, square, pulse, ramp and noise.

3-1-1. Sine Wave

Panel Operation 1. Press the Waveform key.



2. Press F1 (Sine).

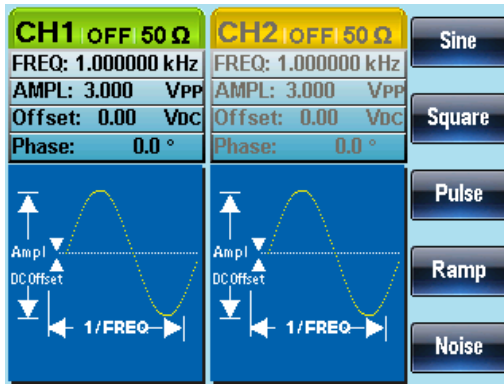

3-1-2. Square Wave

Panel Operation 1. Press the Waveform key.



2. Press F2 (Square) to create a square waveform.



3. Press F1 (Duty). The Duty parameter will be highlighted in the parameter window.



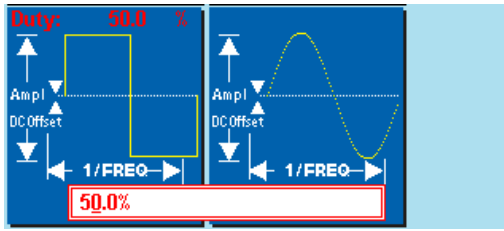

4. Use the arrow keys and scroll wheel or number pad to enter the Duty range.

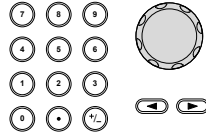

5. Press F2 (%) to select % units.



Range	Frequency	Duty Range
	≤100kHz	1.0%~99.0%
	100kHz~≤1MHz	10.0%~90.0%
	>1MHz~25MHz	50% (Fixed)

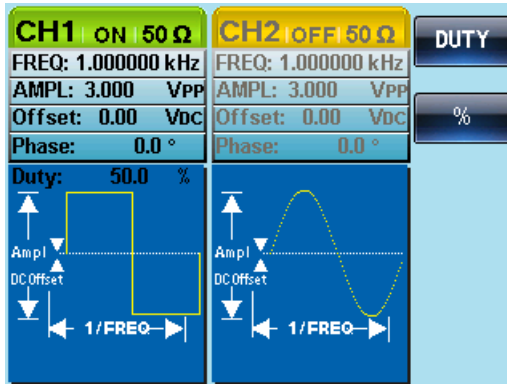

3-1-3. Setting the Pulse Width

- Panel Operation 1. Press the Waveform key.



2. Press F3 (Pulse) to create a pulse width waveform.



3. Press F1 (Width). The Width parameter will be highlighted in the parameter window.

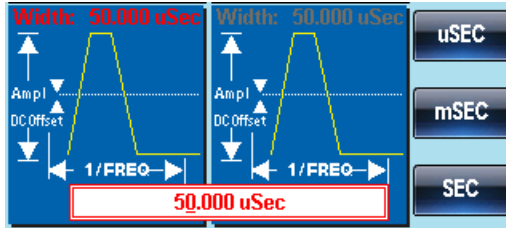

4. Use the arrow keys and scroll wheel or number pad to enter the pulse width.

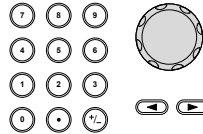

5. Press F2~F5 choose the unit range.

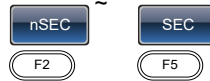

Range	Pulse Width	20ns~1999.9s
Note	Minimum Pulse Width	Frequency \leq 25MHz: 20ns pulse width. Frequency \leq 100 KHz: 1/4096 duty cycle.
	Resolution	Frequency \leq 25MHz: 20ns pulse width. Frequency \leq 100 KHz: 1/4096 duty cycle.

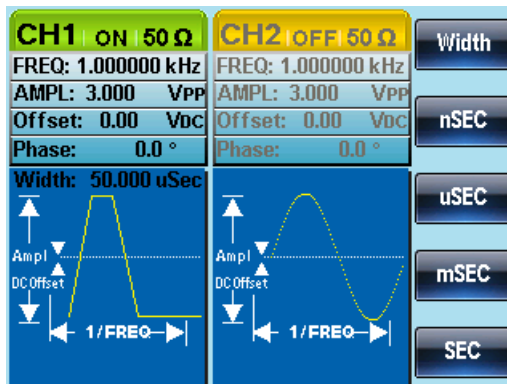



Note

Rise time / Fall time approx.. 17ns(typ.)



Note

Setting of the pulse width can be set up to 20ns, but it is less than 100ns, not a square wave by the specifications.

3-1-4. Setting a Ramp Waveform

Panel Operation 1. Press the Waveform key.



2. Press F4 (Ramp) to create a ramp waveform.



3. Press F1 (SYM). The SYM parameter will be highlighted in the parameter window.

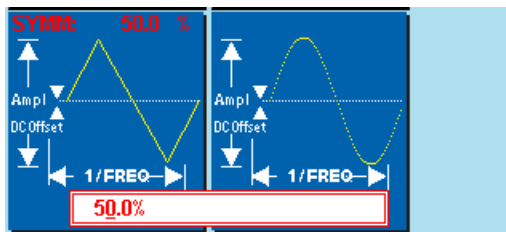

4. Use the arrow keys and scroll wheel or number pad to enter the symmetry percentage.

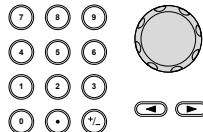

5. Press F2 (%) to choose % units.



Range

Symmetry

0%~100%

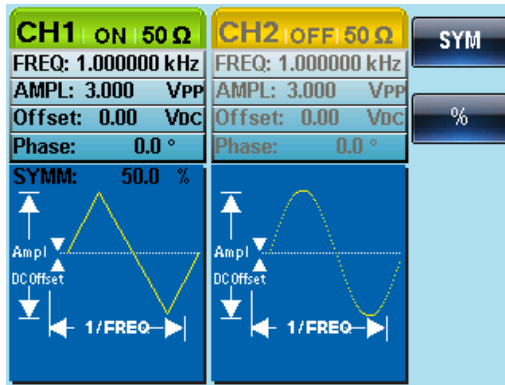

3-1-5. Selecting a Noise Waveform

Panel Operation 1. Press the Waveform key.



2. Press F5 (Noise).

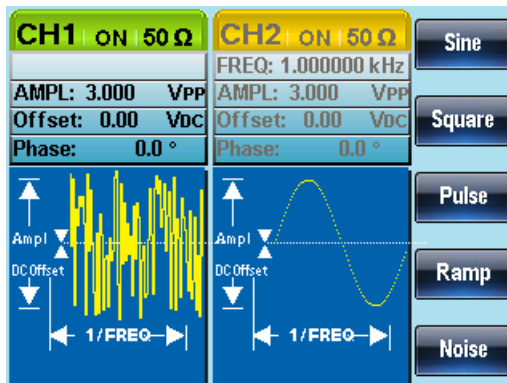

3-1-6.Setting the Frequency

Panel Operation 1. Press the **FREQ/Rate** key.



2. The **FREQ** parameter will become highlighted in the parameter window.



3. Use the arrow keys and scroll wheel or number pad to enter the frequency.

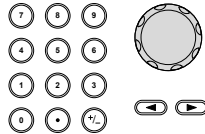

4. Choose a frequency unit by pressing **F1~F5**.



Range	Sine wave	1μHz~25MHz
	Square wave	1μHz~25MHz
	Pulse wave	500μHz~25MHz
	Ramp wave	1μHz~1MHz

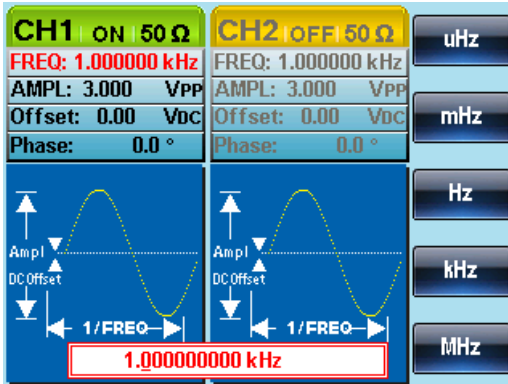

3-1-7. Setting the Amplitude

Panel Operation 1. Press the AMPL key.



2. The AMPL parameter will become highlighted in the parameter window.



3. Use the arrow keys and scroll wheel or number pad to enter the amplitude.

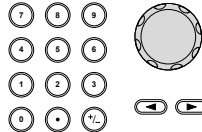

4. Choose a unit type by pressing F1~F5.



	50Ω load	High Z
Range	1mVpp~10Vpp	2mVpp~20Vpp
Unit	Vpp, Vrms, dBm	

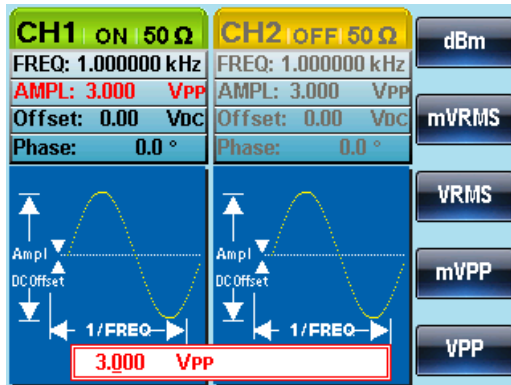

3-1-8. Setting the DC Offset

Panel Operation 1. Press the DC Offset key.



2. The DC Offset parameter will become highlighted in the parameter window.



3. Use the arrow keys and scroll wheel or number pad to enter the DC Offset.

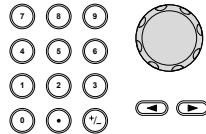

4. Press F1 (mVDC) or F2 (VDC) to choose a voltage range.



	50Ω load	High Z
Range	±5Vpk	±10Vpk

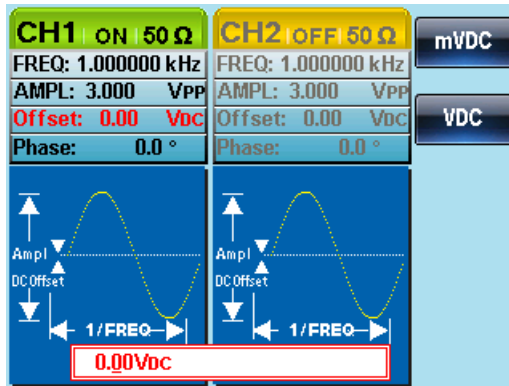

4. MODULATION

The FGX-2220 Series Arbitrary Function Generators are able to produce AM, FM, FSK, PM and SUM modulated waveforms. Depending on the type of waveform produced, different modulation parameters can be set. Only one modulation mode can be active at any one time. The function generator also will not allow sweep or burst mode to be used with AM/FM. Activating a modulation mode will turn the previous modulation mode off.

4-1. Amplitude Modulation (AM)

An AM waveform is produced from a carrier waveform and a modulating waveform. The amplitude of the modulated carrier waveform depends on the amplitude of the modulating waveform. The FGX-2220 function generator can set the carrier frequency, amplitude and offset as well as internal or external modulation sources.

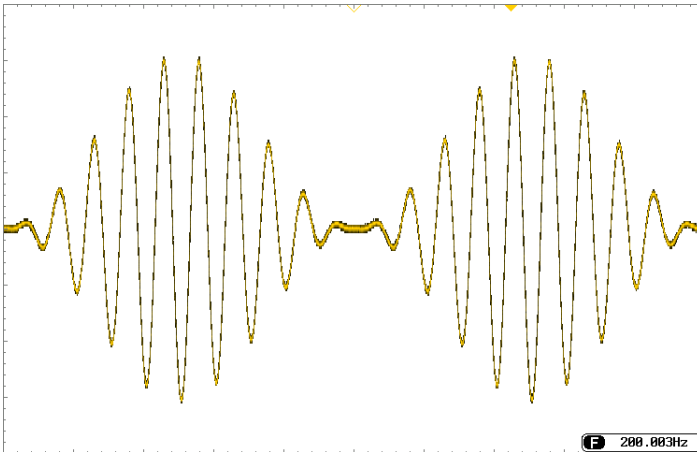

4-1-1. Selecting AM Modulation

Panel Operation 1. Press the MOD key.



2. Press F1 (AM).

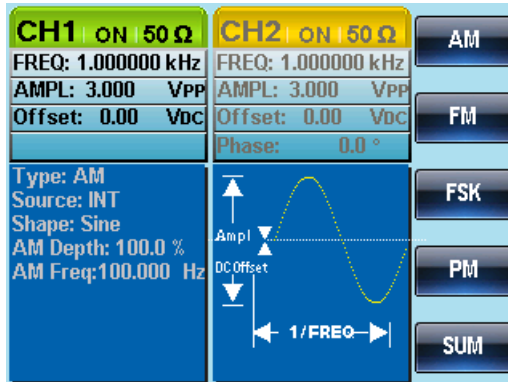

4-1-2. AM Carrier Shape

Background Sine, square, ramp, pulse or arbitrary waveforms can be used as the carrier shape. The default waveform shape is set to sine. Noise is not available as a carrier shape. Before the carrier shape can be selected, choose AM modulation mode, see above.

Select a Standard Carrier Shape 1. Press the Waveform key.



2. Press F1~F4 to choose the carrier wave shape.



Select an Arbitrary Waveform Carrier Shape 3. See the Arbitrary waveform quick reference or chapter to use an arbitrary waveform. Page 15 Page 98

Range AM Carrier Shape sine, square, Ramp, Pulse, arbitrary waveform

4-1-3. Carrier Frequency

The maximum carrier frequency depends on the carrier shape selected. The default carrier frequency for all carrier shapes is 1kHz.

- Panel Operation
1. With a carrier waveform selected, press the **FREQ/Rate** key.



2. The **FREQ** parameter will become highlighted in the parameter window.

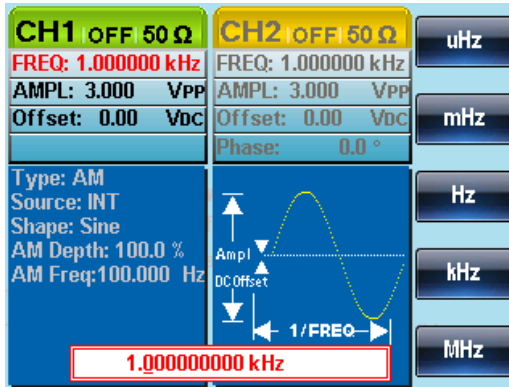

3. Use the arrow keys and scroll wheel or number pad to enter the carrier frequency.

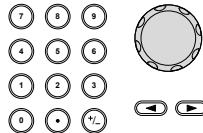



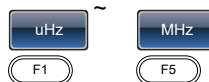







4. Press **F1~F5** to select the frequency range.



Range	Carrier Shape	Carrier Frequency
	Sine wave	1μHz~ 25MHz
	Square wave	1μHz~25MHz
	Ramp wave	1μHz~1MHz
	Pulse wave	500uHz~25MHz
	Default frequency	1 kHz

4-1-4. Modulating Wave Shape

The function generator can accept internal as well as external sources. The FGX-2220 has sine, square, triangle, up ramp and down ramp modulating waveform shapes. Sine waves are the default wave shape.

- Panel Operation
1. Press the MOD key. 
 2. Press F1 (AM).  
 3. Press F4 (Shape).  
 4. Press F1 ~ F5 to select the waveform shape.  
 
 5. Press Return to return to the previous menu. 

Note	Square wave	50% Duty cycle
	UpRamp	100% Symmetry
	Triangle	50% Symmetry
	DnRamp	0% Symmetry

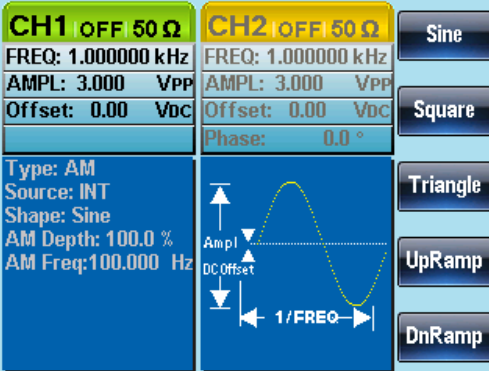

The screenshot shows the control panel for two channels, CH1 and CH2. Both channels are set to 1.000000 kHz, 3.000 Vpp, and 0.00 Vdc. CH2 has a Phase of 0.0°. The Type is AM, Source is INT, and Shape is Sine. The AM Depth is 100.0% and the AM Freq is 100.000 Hz. A central display shows a sine wave with labels for Amplitude, DC Offset, and 1/FREQ. On the right, buttons for Sine, Square, Triangle, UpRamp, and DnRamp are visible.

4-1-5. AM Frequency

The frequency of the modulation waveform (AM Frequency) can be set from 2mHz to 20kHz.

Panel Operation

1. Press the MOD key.



2. Press F1 (AM).



3. Press F3 (AM Freq)



4. The AM Freq parameter will become highlighted in the Waveform display area.

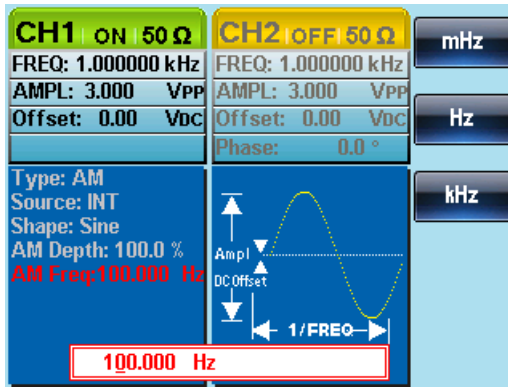

5. Use the arrow keys and scroll wheel or number pad to enter the AM frequency.

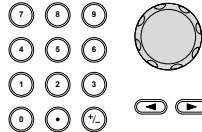

6. Press F1~F3 to select the frequency range.

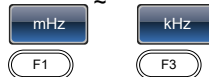

Range	Modulation frequency	2mHz~20kHz
	Default frequency	100Hz

4-1-6. Modulation Depth

Modulation depth is the ratio (as a percentage) of the unmodulated carrier amplitude and the minimum amplitude deviation of the modulated waveform. In other words, modulation depth is the maximum amplitude of the modulated waveform compared to the carrier waveform as a percentage.

Panel Operation 1. Press the MOD key.



2. Press F1 (AM).



3. Press F2 (Depth).



4. The AM Depth parameter will become highlighted in the waveform display area.

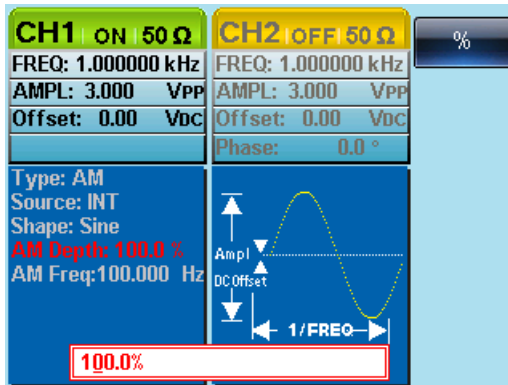

5. Use the arrow keys and scroll wheel or number pad to enter the AM depth.

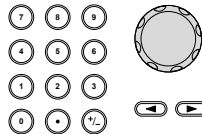

6. Press F1 (%) to choose % units.









Range	Depth	0%~120%
	Default depth	100%

Note When the modulation depth is greater than 100%, the output cannot exceed $\pm 5V_{Peak}$ (10k Ω load). If an external modulation source is selected, modulation depth is limited to $\pm 5V$ from the MOD INPUT terminal on the rear panel. For example, if the modulation depth is set to 100%, then the maximum amplitude is +5V, and the minimum amplitude is -5V.

4-1-7. Selecting the (AM) Modulation Source

The function generator will accept an internal or external source for AM modulation. The default source is internal.

- Panel Operation**
1. Press the MOD key. 
 2. Press F1 (AM). 
 3. Press F1 (Source). 
 4. Press F1 (INT) or F2 (EXT) to select the modulation source.  
 5. Press Return to go back to the previous menu. 

External Source Use the MOD INPUT terminal on the rear panel when using an external source.

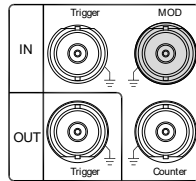

Note If an external modulation source is selected, modulation depth is limited to $\pm 5V$ from the MOD INPUT terminal on the rear panel. For example, if modulation depth is set to 100%, then the maximum amplitude is +5V, and the minimum amplitude is -5V.

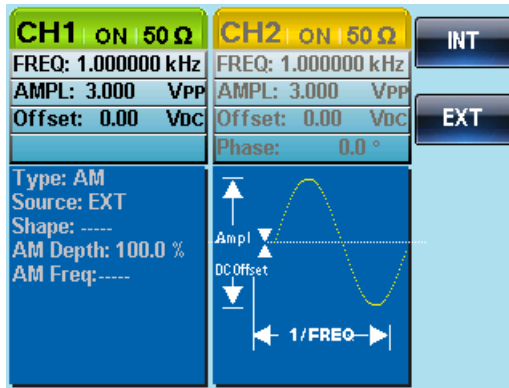

4-2. Frequency Modulation (FM)

A FM waveform is produced from a carrier waveform and a modulating waveform. The instantaneous frequency of the carrier waveform varies with the magnitude of the modulating waveform. When using the FGX-2220 function generator, only one type of modulated waveform can be created at any one time.

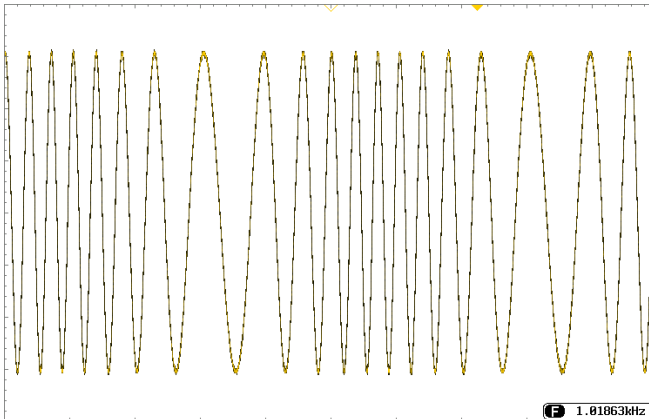

4-2-1. Selecting Frequency Modulation (FM)

When FM is selected, the modulated waveform depends on the carrier frequency, the output amplitude and offset voltage.

Panel Operation 1. Press the MOD key.



2. Press F2 (FM).

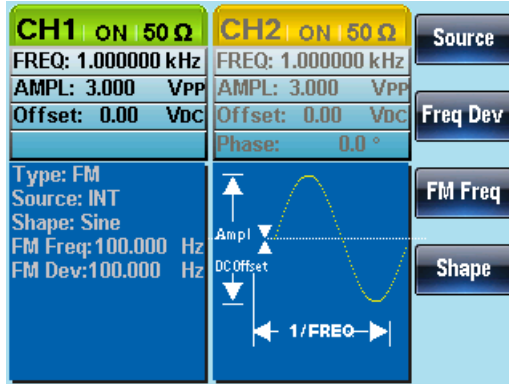

4-2-2. FMCarrier Shape

Background The default waveform shape is set to sine. Noise and pulse waveforms cannot be used as a carrier wave.

Panel Operation 1. Press the Waveform key.



2. Press F1~F4 to select the carrier shape.



Range	Carrier Shape	Sine, Square, Ramp.
-------	---------------	---------------------

4-2-3. FM Carrier Frequency

When using the FGX-2220 function generator, the carrier frequency must be equal to or greater than the frequency deviation. If the frequency deviation is set to value greater than the carrier frequency, the deviation is set to the maximum allowed. The maximum frequency of the carrier wave depends on the waveform shape chosen.

Panel Operation

- To select the carrier frequency, press the FREQ/Rate key.



- The FREQ parameter will become highlighted in the parameter window.

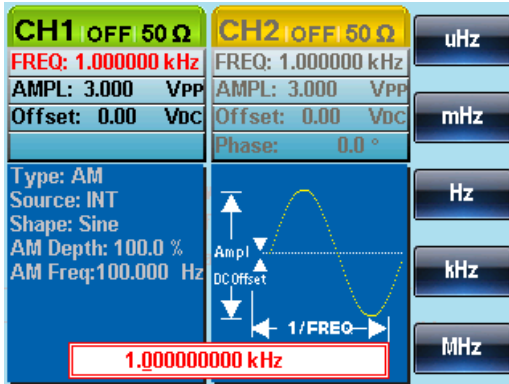

- Use the arrow keys and scroll wheel or number pad to enter the carrier frequency.

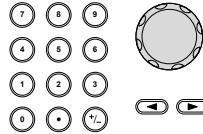



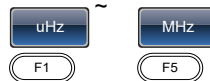







- Press F1~F5 to select the frequency unit.



Range	Carrier Shape	Carrier Frequency
	Sine	1μHz~25MH
	Square	1μHz~15MHz
	Ramp	1μHz~1MHz
	Default frequency	1kHz

4-2-4. FM Wave Shape

The function generator can accept internal as well as external sources. The FGX-2220 has sine, square, triangle, positive and negative ramps (UpRamp, DnRamp) as the internal modulating waveform shapes. Sine is the default wave shape.

- | | | |
|------------|---|--|
| Background | 1. Select MOD. |  |
| | 2. Press F2 (FM). |   |
| | 3. Press F4 (Shape). |   |
| | 4. Press F1 ~ F5 to select the waveform shape. |  
  |
| | 5. Press Return to return to the previous menu. |  |

Range	Square wave	50% Duty cycle
	UpRamp	100% Symmetry
	Triangle	50% Symmetry
	DnRamp	0% Symmetry

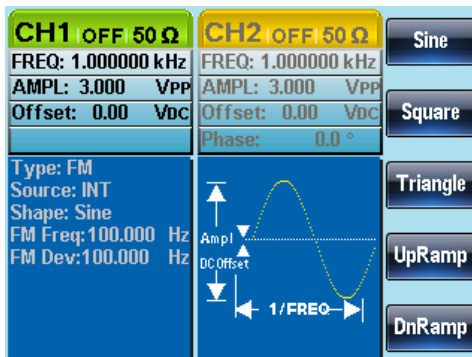

The screenshot displays the function generator's menu and waveform display. The menu shows CH1 and CH2 settings, both at 1.000000 kHz, 3.000 Vpp, and 0.00 Vdc. The Type is FM, Source is INT, Shape is Sine, FM Freq is 100.000 Hz, and FM Dev is 100.000 Hz. The waveform display shows a sine wave with labels for Amplitude, DC Offset, and 1/FREQ. Buttons for Sine, Square, Triangle, UpRamp, and DnRamp are visible on the right.

4-2-5. FM Frequency

The frequency of the modulation waveform (FM Frequency) can be set from 2mHz to 20kHz.

Panel Operation

1. Press the MOD key.



2. Press F2 (FM).



3. Press F3 (FM Freq).



4. The FM Freq parameter will become highlighted in waveform display panel.

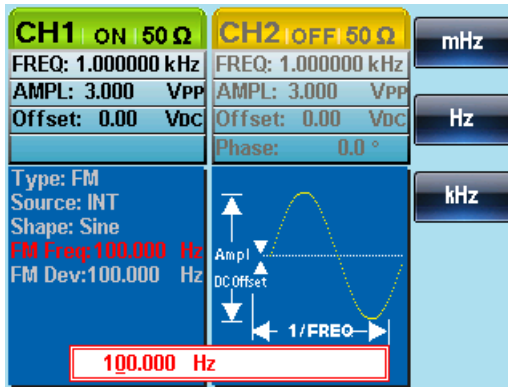

5. Use the arrow keys and scroll wheel or number pad to enter the FM frequency.

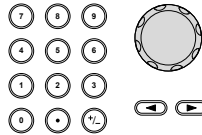

6. Press F1~F3 to select the frequency unit.



Range	Modulation frequency	2mHz~20kHz
	Default frequency	100Hz

4-2-6. Frequency Deviation

The frequency deviation is the peak frequency deviation from the carrier wave and the modulated wave.

Panel Operation

1. Press the MOD key.



2. Press F2 (FM).



3. Press F2 (Freq Dev).



4. The Freq Dev parameter will become highlighted in the waveform display panel.

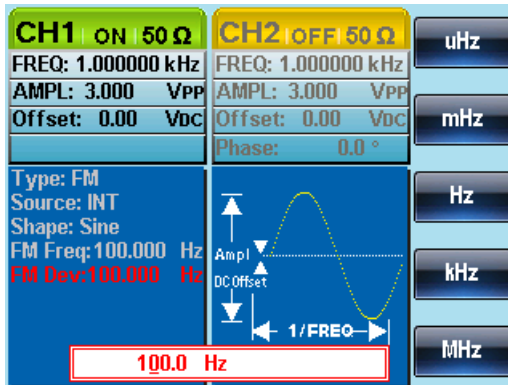

5. Use the arrow keys and scroll wheel or number pad to enter the frequency deviation.

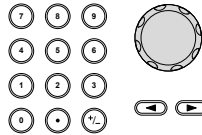











6. Press F1~ F5 to choose the frequency units.



Range	Frequency Deviation	DC~25MHz DC~15MHz(square) DC~1MHz (Ramp)
	Default depth	100Hz

4-2-7. Selecting (FM) Modulation Source

The function generator will accept an internal or external source for FM modulation. The default source is internal.

- | | | |
|-----------------|--|--|
| Panel Operation | 1. Press the MOD key. |  |
| | 2. Press F2 (FM). |   |
| | 3. Press F1 (Source). |   |
| | 4. To select the source, press F1 (Internal) or F2 (External). |  
  |
| | 5. Press Return to return to the previous menu. |  |

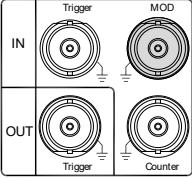
External Source	Use the MOD INPUT terminal on the rear panel when using an external source.	
-----------------	---	---

Note If an external modulating source is selected, the frequency deviation is limited to the $\pm 5V$ MOD INPUT terminal on the rear panel. The frequency deviation is proportional to the signal level of the modulation in voltage. For example, if the modulation in voltage is +5V, then the frequency deviation would be equal to the set frequency deviation. Lower signal levels reduce the frequency deviation while negative voltage levels produce frequency deviations with frequencies below the carrier waveform.

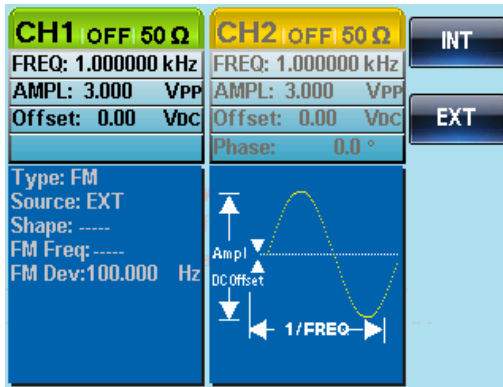

4-3. Frequency Shift Keying (FSK) Modulation

Frequency Shift Keying Modulation is used to shift the frequency output of the function generator between two preset frequencies (carrier frequency, hop frequency). The frequency at which the carrier and hop frequency shift is determined by the internal rate generator or the voltage level from the Trigger INPUT terminal on the rear panel.

Only one modulation mode can be used at once. When FSK modulation is enabled, any other modulation modes will be disabled. Sweep and Burst also cannot be used with FSK modulation. Enabling FSK will disable Sweep or Burst mode.

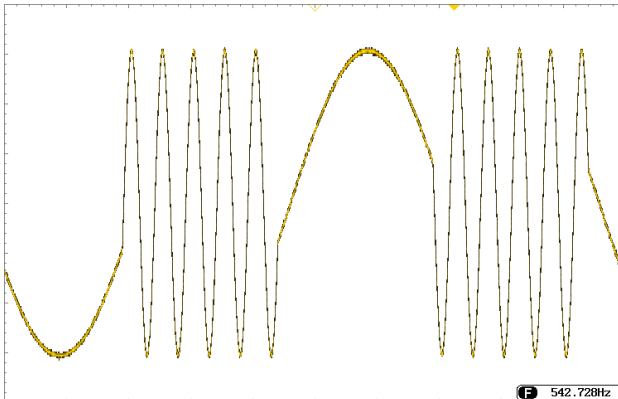

4-3-1. Selecting FSK Modulation

When using FSK mode, the output waveform uses the default settings for carrier frequency, amplitude and offset voltage.

Panel Operation 1. Press the MOD key.



2. Press F3 (FSK).

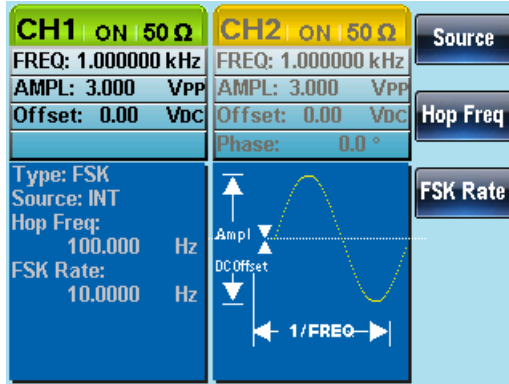

4-3-2. FSK Carrier Shape

Background The default waveform shape is set to sine. Noise waveforms cannot be used as carrier waves.

Panel Operation 1. Press the Waveform key.



2. Press F1~F4 to choose the carrier wave shape.



Range	Carrier Shape	Sine, Square, Pulse, Ramp
-------	---------------	---------------------------

4-3-3. FSK Carrier Frequency

The maximum carrier frequency depends on the carrier shape. The default carrier frequency for all carrier shapes is 1kHz. The voltage level of the Trigger INPUT signal controls the output frequency when EXT is selected. When the Trigger INPUT signal is logically low the carrier frequency is output and when the signal is logically high, the hop frequency is output.

Panel Operation

1. Press the FREQ/Rate key to select the carrier frequency.



2. The FREQ parameter will become highlighted in the parameter window.



3. Use the arrow keys and scroll wheel or number pad to enter the carrier frequency.

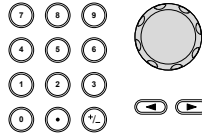

4. Press F1~F5 to select the FSK frequency units.



Range	Carrier Shape	Carrier Frequency
	Sine wave	1μHz~25MHz
	Square wave	1μHz~15MHz
	Ramp wave	1μHz~1MHz
	Pulse wave	500μHz~15MHz
	Default frequency	1kHz

4-3-4. FSK Hop Frequency

The default Hop frequency for all waveform shapes is 100 Hz. A square wave with a duty cycle of 50% is used for the internal modulation waveform. The voltage level of the Trigger INPUT signal controls the output frequency when EXT is selected. When the Trigger INPUT signal is logically low the carrier frequency is output and when the signal is logically high, the hop frequency is output.

Panel Operation

1. Press the MOD key.



2. Press F3 (FSK).



3. Press F2 (Hop Freq).



- The Hop Freq parameter will become highlighted in the Waveform Display area.

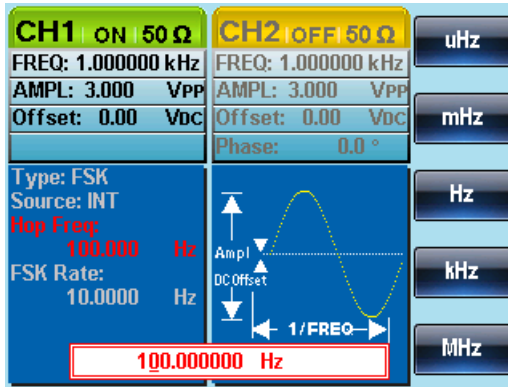

- Use the arrow keys and scroll wheel or number pad to enter the hop frequency.

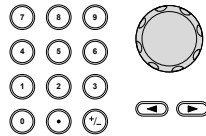

- Press F1~F5 to select the frequency range.

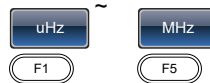

Range	Waveform	Carrier Frequency
	Sine wave	1μHz~25MHz
	Square wave	1μHz~15MHz
	Ramp wave	1μHz~1MHz
	Pulse wave	500μHz~15MHz
	Default frequency	100Hz

4-3-5. FSK Rate

FSK Rate function is used to determine rate at which the output frequency changes between the carrier and hop frequencies. The FSK Rate function only applies to internal FSK sources.

Panel Operation

1. Select the MOD key.



2. Press F3 (FSK).



3. Press F3 (FSK Rate).



4. The FSK Rate parameter will become highlighted in the waveform display area.

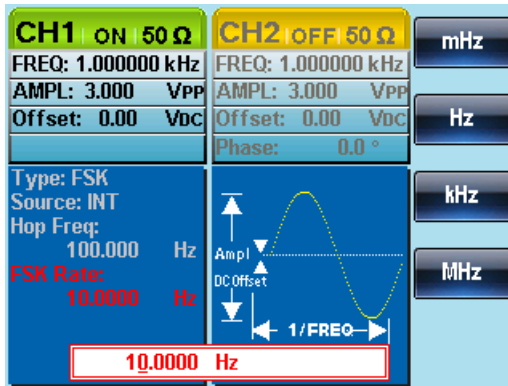

5. The arrow keys and scroll wheel or number pad to enter the FSK rate.

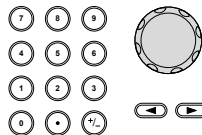

6. Press F1~F4 to select the frequency unit.

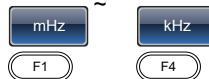











Range	FSK Rate	2mHz~100kHz
	Default	10Hz

Note If an external source is selected, FSK Rate settings are ignored.

4-3-6. FSK Source

The FGX-2220 accepts internal and external FSK sources, with internal as the default source. When the FSK source is set to internal, the FSK rate is configured using the FSK Rate function. When an external signal source is selected the FSK rate is equal to the frequency of the Trigger INPUT signal on the rear panel.

- Panel Operation
1. Press the MOD key. 
 2. Press F3 (FSK).  
 3. Press F1 (Source).  
 4. Press F1 (Internal) or F2 (External) to select the FSK source.  
 
 5. Press Return to return to the previous menu. 

Note Note that the Trigger INPUT terminal cannot configure edge polarity.

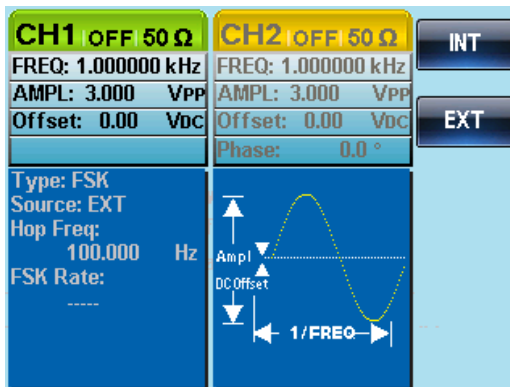

4-4. Phase Modulation (PM)

The phase deviation of the carrier waveform deviates from a reference phase value in proportion to changes in the modulating waveform.

Only one mode of modulation can be enabled at any one time. If PM is enabled, any other modulation mode will be disabled. Likewise, burst and sweep modes cannot be used with PM and will be disabled when PM is enabled.

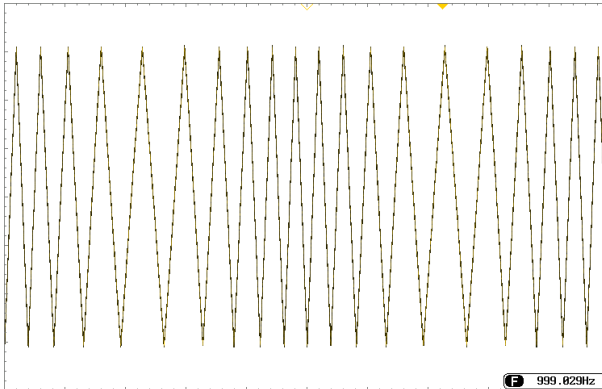

4-4-1. Selecting Phase Modulation (PM)

When selecting PM, the current setting of the carrier frequency, the amplitude modulation frequency, output, and offset voltage must be considered.

Panel Operation 1. Press the MOD key.



2. Press F4 (PM).

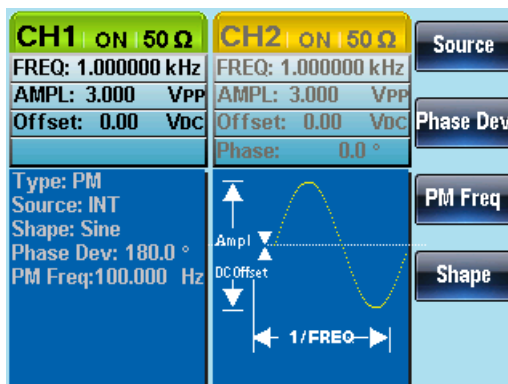





The panel displays settings for two channels, CH1 and CH2. Both channels are set to 1.000000 kHz frequency and 3.000 V_{PP} amplitude. CH1 is set to 0.00 V_{DC} offset, and CH2 is set to 0.0 ° phase. The modulation type is PM, with a source of INT, a sine wave shape, a phase deviation of 180.0 °, and a PM frequency of 100.000 Hz. A diagram shows a sine wave with labels for Amplitude, DC Offset, and 1/FREQ.

CH1 ON 50 Ω	CH2 ON 50 Ω	Source
FREQ: 1.000000 kHz	FREQ: 1.000000 kHz	
AMPL: 3.000 V _{PP}	AMPL: 3.000 V _{PP}	Phase Dev
Offset: 0.00 V _{DC}	Offset: 0.00 V _{DC}	PM Freq
Type: PM	Phase: 0.0 °	Shape
Source: INT		
Shape: Sine		
Phase Dev: 180.0 °		
PM Freq: 100.000 Hz		

4-4-2. PM Carrier Waveform

Background PM uses a sine wave as default. Noise and Pulse waveform cannot be used with phase modulation.

- Panel Operation**
1. Press the Waveform key. 
 2. Press F1 ~ F4 to select the waveform.  ~ 
 





Range Carrier Waveform Sine wave, Square wave, ramp wave.

4-4-3. PM Carrier Frequency

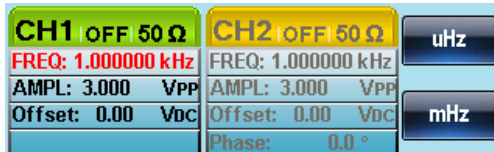
Selects the maximum carrier frequency for the carrier waveform. The default carrier frequency is 1kHz.

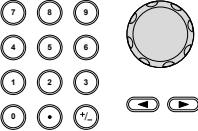
- Panel Operation**
1. Press the FREQ/Rate key to select the carrier frequency. 
 2. The FREQ parameter will become highlighted in the parameter window.













3. Use the arrow keys and scroll wheel or number pad to enter the carrier frequency. 
4. Press F1~F5 to select the frequency unit.  ~ 
 

Range	Carrier Wave	Carrier Frequency
	Sine wave	1μHz~25MH
	Square wave	1μHz~15MHz
	Ramp wave	1μHz~1MHz
	Default frequency	1 kHz

4-4-4. PM Wave Shape

The function generator can accept internal or external sources. The internal sources can include sine, square, triangle, up ramp and down ramp. The default wave shape is sine.

- Panel Operation
1. Select the MOD key. 
 2. Press F4 (PM).  
 3. Press F4 (Shape).  
 4. Press F1~F5 to select a waveform shape.  
 
 5. Press Return to return to the previous menu. 

Range	Waveform	
	Square wave	50% Duty Cycle
	Up Ramp	100% Symmetry
	Triangle	50% Symmetry
	Dn Ramp	0% Symmetry

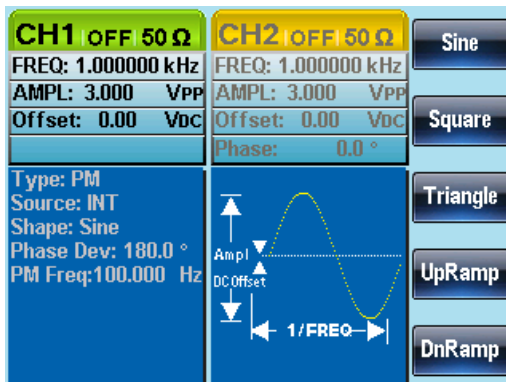

4-4-5. PM Frequency

The frequency of the modulation waveform (PM Frequency) can be set from 2mHz to 20kHz.

Panel Operation

1. Press the MOD key.



2. Press F4 (PM).



3. Press F3 (PM Freq).



4. The PM Freq parameter will become highlighted in the Waveform Display area.

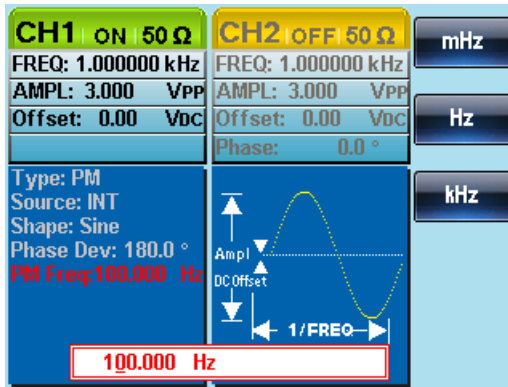

5. Use the arrow keys and scroll wheel or number pad to enter the PM frequency.

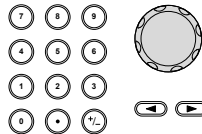

6. Press F1~F3 to select the frequency unit range.

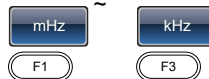

Range

Modulation frequency

2mHz~20kHz

Default frequency

100Hz

4-4-6. Phase Deviation

The maximum phase deviation depends on the the carrier wave frequency and the modulated waveform.

Panel operation

1. Press the MOD key.



2. Press F4 (PM).



3. Press F2 (Phase Dev).



4. The Phase Dev parameter will become highlighted in the waveform display area.

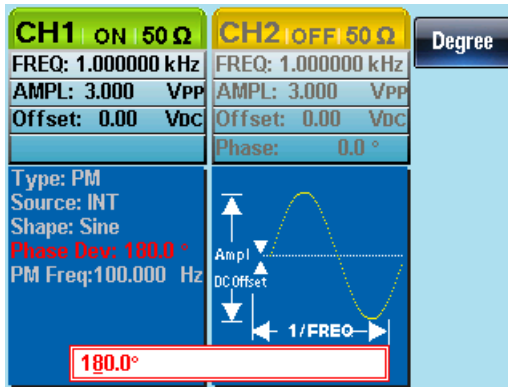

5. Use the arrow keys and scroll wheel or number pad to enter the phase deviation.

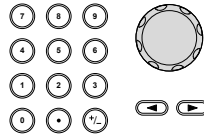











6. Press F1 to select the phase units.



Range	Phase deviation/shift	0~360°
	Default phase	180°

4-4-7. Select the PM Source

The function generator accepts internal or external sources for phase modulation. The default source is internal.

- | | | |
|-----------------|---|--|
| Panel Operation | 1. Press the MOD key. |  |
| | 2. Press F4 (PM). |   |
| | 3. Press F1 (Source). |   |
| | 4. Press F1 (INT) or F2 (EXT) to select the source. |  
  |
| | 5. Press return to return to the previous menu. |  |

External Source Use the MOD INPUT terminal on the rear panel when using an external source.

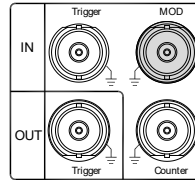

Note If the modulation source is set to external, the phase deviation is controlled by the $\pm 5V$ MOD INPUT terminal on the rear panel. For example, if the modulation voltage is $+5V$, then the phase deviation is equal to the phase deviation setting. If the modulation voltage is less than $+5V$, then the phase deviation will be less than the phase deviation setting.

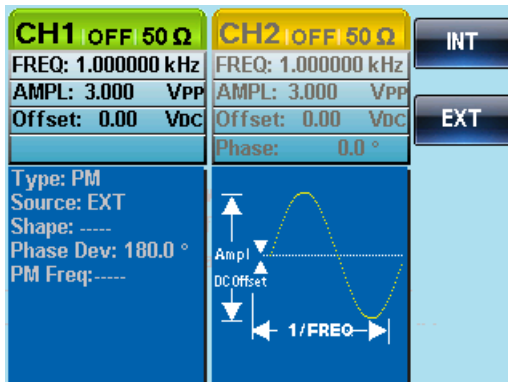

4-5. SUM modulation

Sum modulation adds a modulating signal to a carrier wave. Typically, sum modulation is used to add noise to a carrier wave. The modulating signal is added as a percentage of the carrier amplitude.

If SUM is enabled, any other modulation mode will be disabled. Likewise, burst and sweep modes cannot be used with SUM and will be disabled when SUM is enabled.

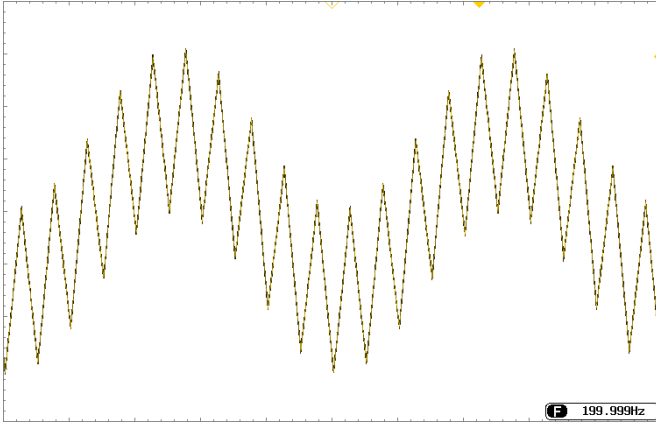

4-5-1. Selecting SUM modulation

For SUM modulation, the modulated waveform amplitude and offset is determined by the carrier wave.

Panel Operation 1. Press the MOD key.



2. Press F5 (SUM).

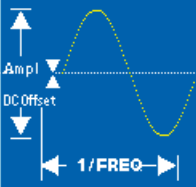

CH1 ON 50 Ω FREQ: 1.000000 kHz AMPL: 3.000 V _{PP} Offset: 0.00 V _{DC}	CH2 ON 50 Ω FREQ: 1.000000 kHz AMPL: 3.000 V _{PP} Offset: 0.00 V _{DC} Phase: 0.0 °	Source
Type: SUM Source: INT Shape: Sine SUM Ampl: 50.0 % SUM Freq: 100.000 Hz		SUM Ampl
		SUM Freq
		Shape

4-5-2. SUM Carrier Waveform

Background

The SUM carrier waveform is a sinewave by default.

Panel Operation

1. Press the Waveform key.



2. Press F1~F5 to select the carrier waveform.

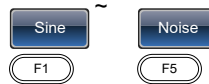

Range

Carrier Waveform

Sine, square, pulse, ramp and noise wave.

4-5-3. SUM Carrier Frequency

The maximum carrier frequency depends on the selected carrier waveform. The default carrier frequency is 1kHz.

Panel Operation

1. Press the FREQ/Rate key to select the carrier frequency.



2. The FREQ parameter will become highlighted in the parameter window.

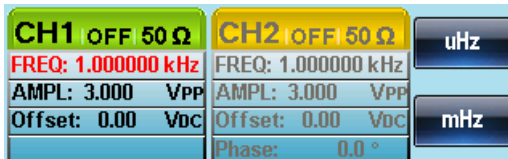

3. Use the arrow keys and scroll wheel or number pad to enter the frequency.

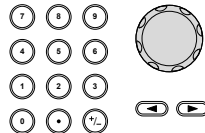



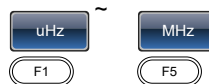







4. Press F1 ~ F5 to select the frequency units.



Range	Carrier Waveform	Carrier Frequency
	Sine wave	1μHz~25MH
	Square wave	1μHz~25MHz
	Pulse wave	500μHz~25MHz
	Ramp wave	1μHz~1MHz
	Default frequency	1 kHz

4-5-4. SUM Waveform

The function generator can accept internal and external sources. The FGX-2220 includes sine, square, triangle, UpRamp and DnRamp as internal sources. The default waveform is sine.

- Panel Operation
1. Press the MOD key. 
 2. Press F5 (SUM).  
 3. Press F4 (Shape).  
 4. Press F1~F5 to select the source waveform.  
 
 5. Press Return to return to the previous menu. 

Range	Square wave	50% Duty cycle
	Up ramp	100% Symmetry
	Triangle	50% Symmetry
	Down ramp	0% Symmetry

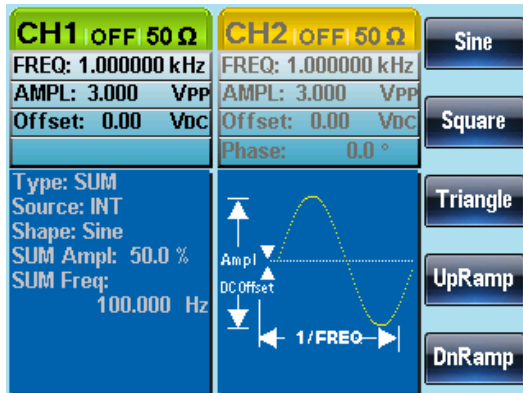

4-5-5. Modulating Waveform Frequency

The frequency of the modulating waveform (SUM Frequency) can be set from 2mHz to 20kHz.

Panel Operation

1. Press the MOD key.



2. Press F5 (SUM).



3. Press F3 (SUM Freq).



4. The SUM Freq parameter will become highlighted in the waveform display area.

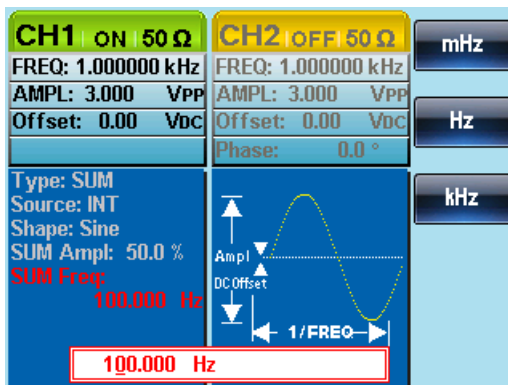

5. Use the arrow keys and scroll wheel or number pad to enter the SUM frequency.

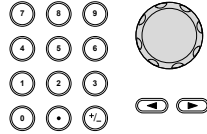

6. Press F1~F3 to select the frequency units.

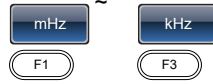

Range	Modulating range	2mHz~20kHz
	Default frequency	100Hz

4-5-6. SUM Amplitude

The SUM amplitude is the offset (in percent relative to the carrier) of the signal that is added to the carrier.

- Panel Operation 1. Press the MOD key.



2. Press F5 (SUM).



3. Press F2 (SUM Ampl).



4. In the waveform display area, the SUM Ampl will be highlighted.

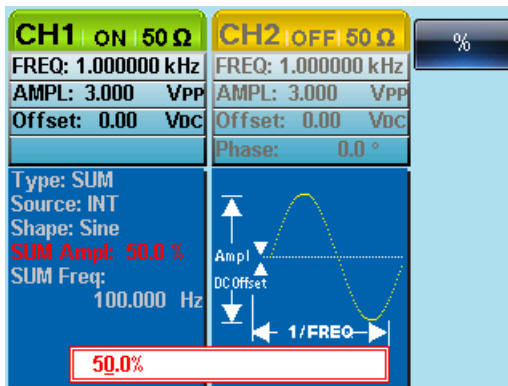

5. Use the arrow keys and scroll wheel or number pad to enter the SUM amplitude.

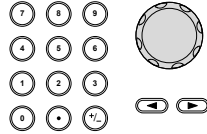

6. Press F1 to select the percentage unit.



Range	Sum amplitude	0~100%
	Default amplitude	50%

4-5-7. Select the SUM Amplitude Source

The signal generator can accept internal or external sources for the SUM amplitude modulation.

- Panel Operation 1. Press the MOD key.



2. Press F5 (SUM).



3. Press F1 (Source).



4. Press F1 (INT) or F2 (EXT) to select the source.



5. Press Return to return to the previous menu.



- External Source Use the MOD INPUT terminal on the rear panel when using an external source.

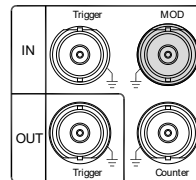

Note If an external modulation source is selected, the SUM amplitude is controlled by the $\pm 5V$ from the MOD INPUT terminal on the rear panel. For example, if the SUM amplitude is set to 50%, then the maximum amplitude (150% of the carrier) will be at +5V, and the minimum amplitude (50% of the carrier) will be at -5V.

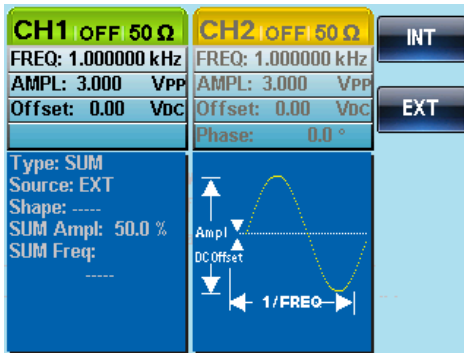

4-6. Frequency Sweep

The function generator can perform a sweep for sine, square or ramp waveforms, but not noise, and pulse. When Sweep mode is enabled, Burst or any other modulation modes will be disabled. When sweep is enabled, burst mode is automatically disabled.

In Sweep mode the function generator will sweep from a start frequency to a stop frequency over a number of designated steps. The step spacing of the sweep can be linear or logarithmic. The function generator can also sweep up or sweep down in frequency. If manual or external sources are used, the function generator can be used to output a single sweep.

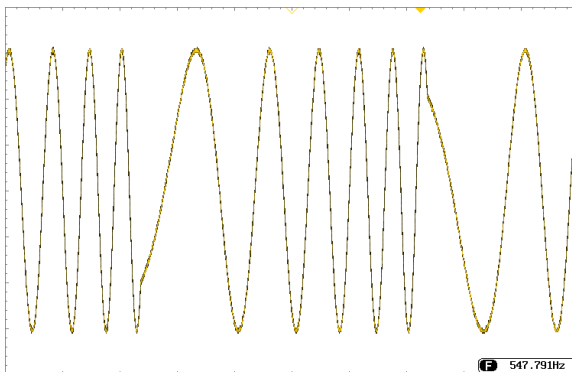

4-6-1. Selecting Sweep Mode

The Sweep button is used to output a sweep. If no settings have been configured, the default settings for output amplitude, offset and frequency are used.



4-6-2. Setting Start and Stop Frequency

The start and stop frequencies define the upper and lower sweep limits. The function generator will sweep from the start through to the stop frequency and cycle back to the start frequency. The sweep is phase continuous over the full range sweep range (1μHz-25MHz).

Panel Operation 1. Press the SWEEP key.



2. Press F3 (Start) or F4 (Stop) to select the start or stop frequency.



3. The Start or Stop parameter will become highlighted in the waveform display area.

Start

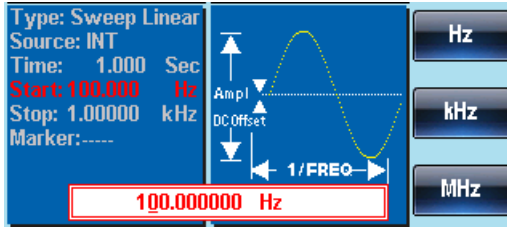

Stop

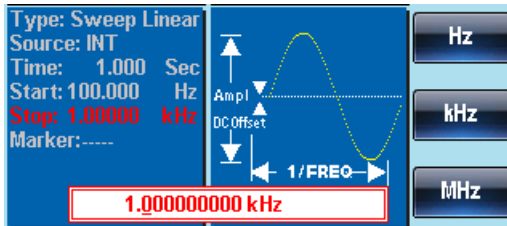

4. Use the arrow keys and scroll wheel or number pad to enter the Stop/Start frequency.

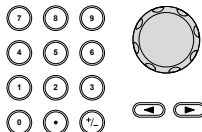

5. Press F1~F5 to select the Start/Stop frequency units.

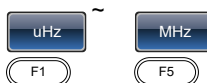

Range	Sweep Range	1μHz~25MHz (Sine wave) 1μHz~1MHz (Ramp wave) 1μHz~15MHz (Square wave)
	Start - Default	100Hz
	Stop - Default	1kHz

Note

To sweep from low to high frequencies, set the start frequency less than the stop frequency.

To sweep from high to low frequencies, set the start frequency greater than the stop frequency.

When marker is off, the SYNC signal is a square wave with a duty cycle of 50%. At the start of the sweep, the SYNC signal is at a TTL low level that rises to a TTL high level at the frequency midpoint. The frequency of the SYNC signal is equal to the sweep time.

When marker is on, at the start of the sweep, the SYNC signal is at a TTL high level that drops to a TTL low level at the marker. The SYNC signal is output from the mark output terminal.

4-6-3. Center Frequency and Span

A center frequency and span can be set to determine the upper and lower sweep limits (start/stop).

Panel Operation

1. Press the SWEEP key.



2. Press F5 (More).



3. Press F2 (Span) or F3 (Center) to select the span or center.

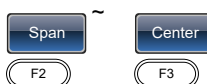

4. The Span or Center parameters will become highlighted in the waveform display area.

Span

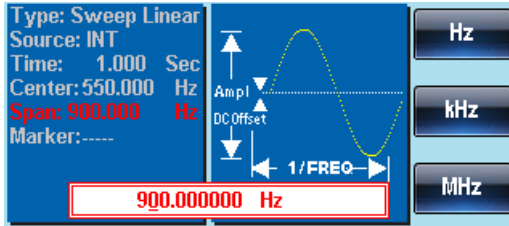

Center

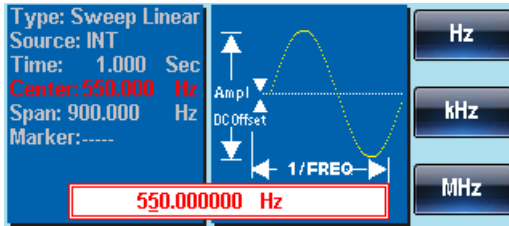

5. Use the arrow keys and scroll wheel or number pad to enter the Span/Center frequency.

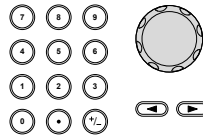

6. Press F1~F5 to select the Start/Stop frequency units.

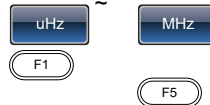

Range	Center frequency	1μHz~25MHz (sine wave) 1μHz~1MHz (Ramp wave) 1μHz~15MHz (square wave)
	Span frequency	DC~25MHz (sine wave) DC ~1MHz (Ramp wave) 1μHz~15MHz (square wave)
	Default center	550Hz
	Default span	900Hz

Note

To sweep from low to high frequencies, set a positive span. To sweep from high to low frequencies, set a negative span.

When marker is off, the SYNC signal is a square wave with a duty cycle of 50%. At the start of the sweep, the SYNC signal is at a TTL low level that rises to a TTL high level at the frequency midpoint. The frequency of the SYNC signal is equal to the sweep time.

When marker is on, at the start of the sweep, the SYNC signal is at a TTL high level that drops to a TTL low level at the marker. The SYNC signal is output from the mark output terminal.

4-6-4. Sweep Mode

Sweep mode is used to select between linear or logarithmic sweeping. Linear sweeping is the default setting.

Panel Operation

1. Press the SWEEP key.



2. Press F2 (Type).



3. To select linear or logarithmic sweep, press F1 (Linear) or F2 (Log).



4. Press Return to return to the previous menu.

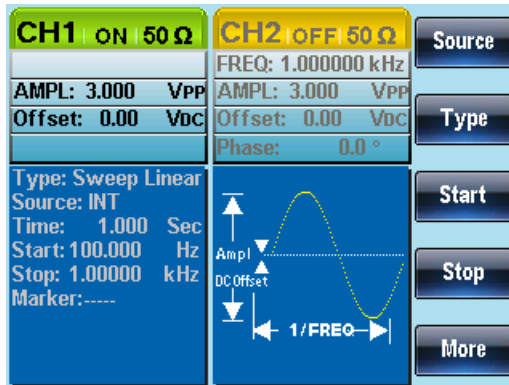

4-6-5. Sweep Time

The sweep time is used to determine how long it takes to perform a sweep from the start to stop frequencies. The function generator automatically determines the number of discrete frequencies used in the scan depending on the length of the scan.

Panel Operation 1. Press the SWEEP key.



2. Press F5 (More).



3. Press F1 (SWP Time).



4. The Time parameter will become highlighted in the waveform display area.

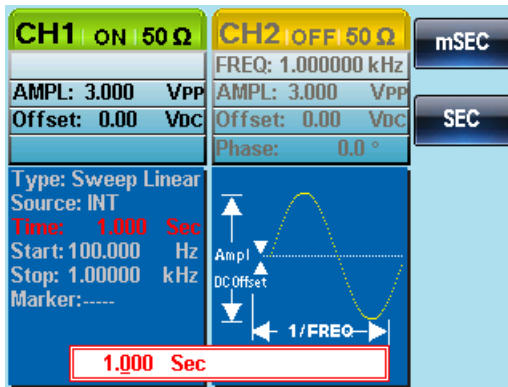

5. Use the selector keys and scroll wheel or number pad to enter the Sweep time.

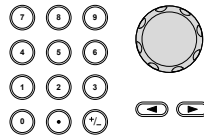



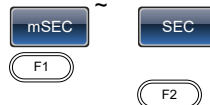





6. Press F1~F2 to select the time unit.







Range	Sweep time	1ms ~ 500s
	Default time	1s

4-6-6. Marker Frequency

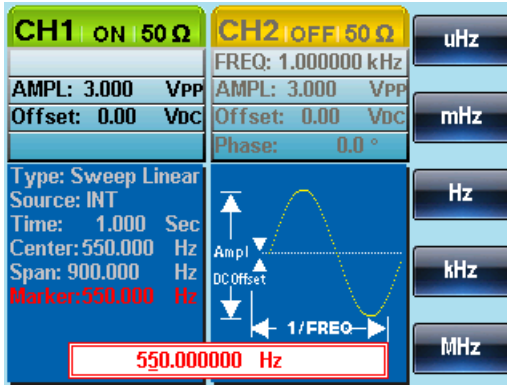
The marker frequency is the frequency at which the marker signal goes low (The marker signal is high at the start of each sweep). The marker signal is output from the Trigger OUT terminal on the rear panel. The default is 550 Hz.

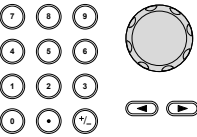
- Panel Operation
1. Press the SWEEP key. 
 2. Press F5 (More).  
 3. Press F4 (Marker)  
 4. Press F2 (ON/OFF) to toggle the marker on or off.  
 5. Press F1 (Freq) to select the marker frequency.  
 6. The Marker parameter will become highlighted in the waveform display area.



7. Use the arrow keys and scroll wheel or number pad to enter the frequency. 
8. Press F1~F5 to select the frequency unit.    





Range	Frequency	1μHz~25MHz(Sine wave) 1μHz~1MHz (Ramp wave) 1μHz~15MHz (square wave)
	Default	550Hz

Note The marker frequency must be set to a value between the start and stop frequencies. If no value is set, the marker frequency is set to the average of the start and stop frequencies.

Marker mode will override SYNC mode settings when sweep mode is active.

4-6-7. Sweep Trigger Source

In sweep mode the function generator will sweep each time a trigger signal is received. After a sweep output has completed, the function generator outputs the start frequency and waits for a trigger signal before completing the sweep. The default trigger source is internal.

- Panel Operation**
1. Press the SWEEP key. 
 2. Press F1 (Source). 
 3. To select the trigger source, press F1 (Internal), F2 (External) or F3 (Manual). 
 4. Press Return to return to the previous menu. 

Note Using the Internal source will produce a continuous sweep using the sweep time settings.

With an external source, a sweep is output each time a trigger pulse (TTL) is received from the Trigger IN terminal on the rear panel.

The trigger period must be equal to or greater than the sweep time plus 1ms.

5. If manual is selected, press F1 (Trigger) to manually start each sweep. 

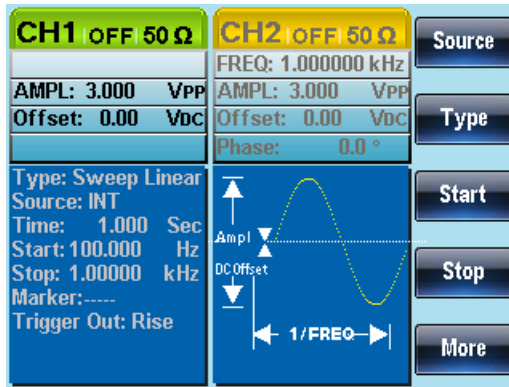

4-7. Burst Mode

The function generator can create a waveform burst with a designated number of cycles. Burst mode supports sine, square and ramp waveforms.

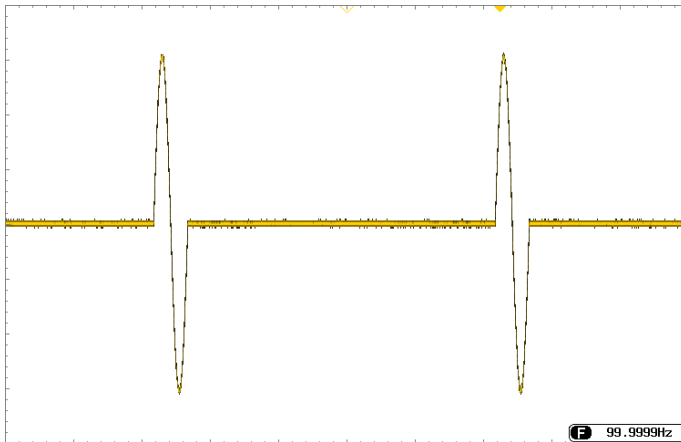

4-7-1. Selecting Burst Mode

When burst mode is selected, any modulation or sweep modes will be automatically disabled. If no settings have been configured, the default settings for output amplitude, offset and frequency are used.

Burst

4-7-2. Burst Modes

Burst mode can be configured using Triggered (N Cycle mode) or Gated mode. Using N Cycle/Triggered mode, each time the function generator receives a trigger, the function generator will output a specified number of waveform cycles (burst). After the burst, the function generator will wait for the next trigger before outputting another burst. N Cycle is the default Burst mode. Triggered mode can use internal or external triggers.

The alternative to using a specified number of cycles, Gated mode uses the external trigger to turn on or off the output. When the Trigger INPUT signal is high, waveforms are continuously output. When the Trigger INPUT signal goes low, the waveforms will stop being output after the last waveform completes its period. The voltage level of the output will remain equal to the starting phase of the burst waveforms, ready for the signal to go high again.

Burst Mode	Burst Count	Burst Period	Phase	Trigger Source
Triggered (Int)	Available	Available	Available	Immediate
Triggered (Ext)	Available	Not used	Available	EXT, Bus
Gated pulse (Ext)	Not used	Not used	Available	Unused

Panel Operation 1. Press the Burst key.



2. To select either N Cycle (F1) or Gate (F2).

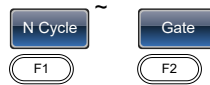

Note

In gate mode, burst count, burst cycle, trigger source will be ignored, Also trigger source will be only in the external trigger signal.

4-7-3. Burst Frequency

In the N Cycle and Gated modes, the waveform frequency sets the repetition rate of the burst waveforms. In N-Cycle mode, the burst is output at the waveform frequency for the number of cycles set. In Gated mode the waveform frequency is output while the trigger is high. Burst mode supports sine, square or ramp waveforms.

Panel Operation 1. Press the FREQ/Rate key.



2. The FREQ parameter will become highlighted in the parameter window.



3. Use the arrow keys and scroll wheel or number pad to enter the frequency.

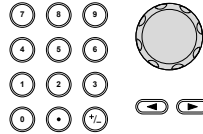

4. Press F1~F5 to select the frequency unit.





Range	Frequency	1uHz~25MHz
	Frequency – Ramp	1uHz~1MHz
	Default	1kHz

Note Waveform frequency and burst period are not the same. The burst period is the time between the bursts in N-Cycle mode.

4-7-4. Burst Cycle/Burst Count

The burst cycle (burst count) is used to define the number of cycles that are output for a burst waveform. Burst cycle is only used with N-cycle mode (internal, external or manual source). The default burst cycle is 1.

- Panel Operation
1. Press the Burst key. 
 2. Press F1 (N Cycle). 
 3. Press F1 (Cycles). 
 4. The Cycles parameter will become highlighted in the Waveform Display area.

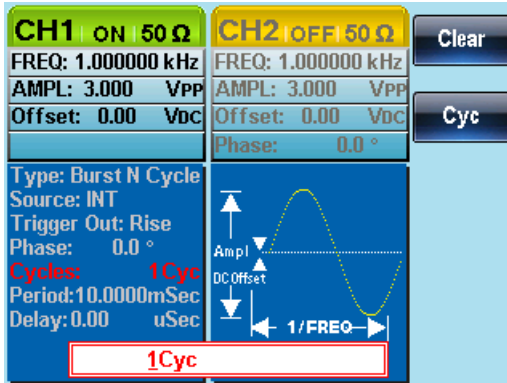

5. Use the arrow keys and scroll wheel or number pad to enter the number of cycles.

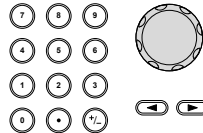

6. Press F2 to select the Cyc unit.



Range	Cycles	1-65535
-------	--------	---------

Note Burst cycles are continuously output when the internal trigger is selected. The burst period determines the rate of bursts and the time between bursts.





Burst cycle must be less than the product of the burst period and wave frequency.

$$\text{Burst Cycle} < (\text{Burst Period} \times \text{Wave Frequency})$$

If the burst cycle exceeds the above conditions, the burst period will be automatically increased to satisfy the above conditions.

If gated burst mode is selected, burst cycle is ignored. Though, if the burst cycle is changed remotely whilst in gated mode, the new burst cycle is remembered when used next.

4-7-5. Infinite Burst Count



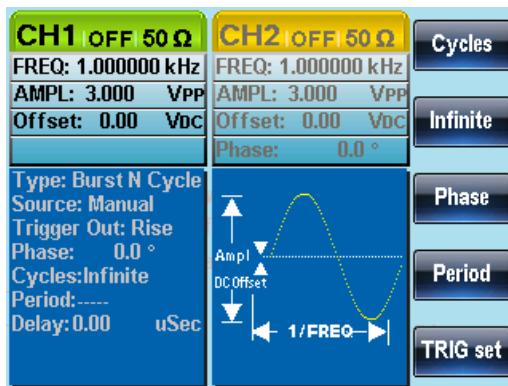

- Panel Operation
1. Press the Burst key. 
 2. Press F1 (N Cycle).  
 3. Press F2 (Infinite).  

Note Infinite burst is only available when using manual triggering.



4-7-6. Burst Period

The burst period is used to determine the time between the start of one burst and the start of the next burst. It is only used for internally triggered bursts.

- Panel Operation
1. Press the Burst key. 
 2. Press F1 (N Cycle).  
 3. Press F4 (Period).  
 4. The Period parameter will become highlighted in the Waveform Display area.

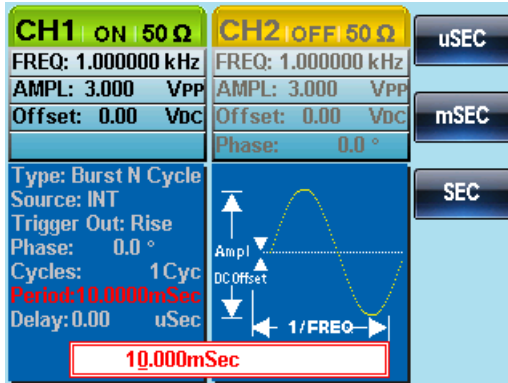

5. Use the arrow keys and scroll wheel or number pad to enter period time.

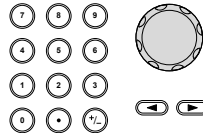

6. Press F1~F3 to choose the period time unit.

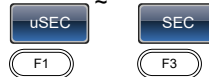

Range	Period time	1ms~500s
	Default	10ms

Note Burst period is only applicable for internal triggers. Burst period settings are ignored when using gated burst mode or for external and manual triggers.

The burst period must be large enough to satisfied the condition below:

$$\text{Burst Period} > \text{Burst Count} / \text{Wave frequency} + 200\text{ns}.$$

4-7-7. Burst Phase

Burst Phase defines the starting phase of the burst waveform. The default is 0°.

- Panel Operation 1. Press the Burst key.



2. Press F1 (N Cycle).



3. Press F3 (Phase).



4. The Phase parameter will become highlighted in the Waveform Display area.

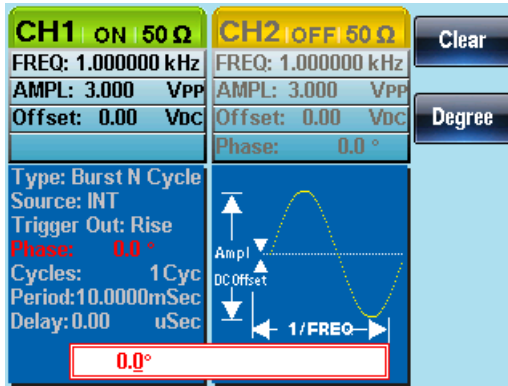

5. Use the arrow keys and scroll wheel or number pad to enter the phase.

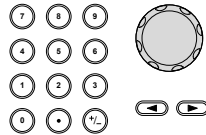

6. Press F2 (Degree) to select the phase unit.



Range	Phase	-360°~+360°
	Default	0°









Note When using sine, square, triangle or ramp waveforms, 0° is the point where the waveforms are at zero volts.



0° is the starting point of a waveform. For sine, square or Triangle, Ramp waveforms, 0° is at 0 volts (assuming there is no DC offset).

Burst Phase is used for both N cycle and Gated burst modes. In gated burst mode, when the Trigger INPUT signal goes low the output is stopped after the current waveform is finished. The voltage output level will remain equal to the voltage at the starting burst phase.

4-7-8. Burst Trigger Source

Each time the function generator receives a trigger in triggered burst (N-Cycle) mode, a waveform burst is output. The number of waveforms in each burst is designated by the burst cycle (burst count). When a burst has completed, the function generator waits for the next trigger. Internal source is the default triggered burst (N-cycle) mode on power up.

- Panel Operation
1. Press the Burst key. 
 2. Press F1 (N Cycle).  
 3. Press F5 (TRIG set).  
 4. Choose a trigger type by pressing F1 (INT), F2 (EXT) or F3 (Manual).  
 

Manual Triggering If a manual source is selected, the Trigger softkey (F1) must be pressed each time to output a burst.  

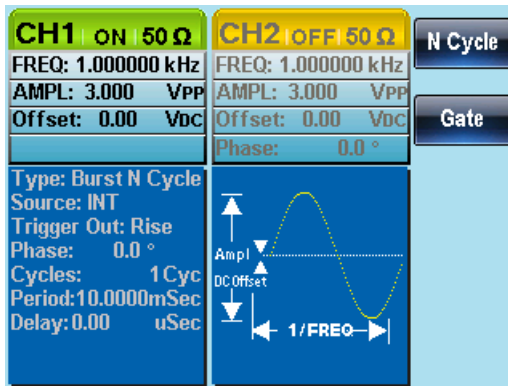

Note

When the internal trigger source is chosen, the burst is output continuously at a rate defined by the burst period setting. The interval between bursts is defined by the burst period.

When the external trigger is selected the function generator will receive a trigger signal (TTL) from the Trigger INPUT terminal on the rear panel. Each time the trigger is received, a burst is output (with the defined number of cycles). If a trigger signal is received during a burst, it is ignored.

When using the manual or external trigger only the burst phase and burst cycle/count are applicable, the burst period is not used.

A time delay can be inserted after each trigger, before the start of a burst.

4-7-9. Burst Delay

Panel Operation

1. Press the Burst key.



2. Press F1 (N Cycle).



3. Press F5 (TRIG set).



4. Press F4 (Delay).



5. The Delay parameter will become highlighted in the Waveform Display area.

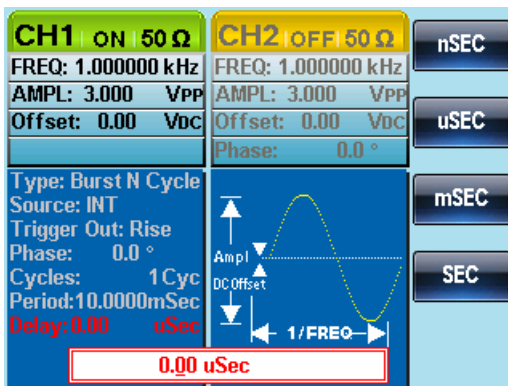

6. Use the selector keys and scroll wheel or number pad to enter period time.

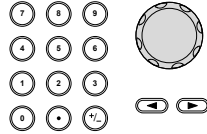

7. Press F1~F4 to choose the delay time unit.

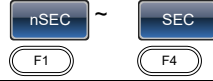

Range	Delay time	0s~655350nS
	Default	0s

4-7-10. Burst Trigger Output

The Trig Out terminal on the rear panel can be used for burst or sweep modes to output a rising edge TTL compatible trigger signal. By default the trigger signal is rising edge. The trigger signal is output at the start of each burst.

Panel Operation

1. Press the Burst key.



2. Press F1 (N Cycle).



3. Press F5 (TRIG set).



4. Press F5 (TRIG out).



5. Press F3 (ON/OFF) to toggle Trigger out ON/OFF.



6. Select F1 (Rise) or F2 (Fall) edge trigger.

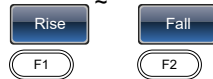

Note

When the internal trigger is selected, a square wave with a 50% duty cycle is output at the beginning of each burst.

Trig Out cannot be used with manual triggering and will be disabled if manual triggering is set.

For manual triggering, a pulse is output (>1us) from the Trig Out connector at the start of each burst.

CH1 OFF 50 Ω	CH2 OFF 50 Ω	Rise
FREQ: 1.000000 kHz	FREQ: 1.000000 kHz	
AMPL: 3.000 Vpp	AMPL: 3.000 Vpp	Fall
Offset: 0.00 Vdc	Offset: 0.00 Vdc	
	Phase: 0.0 °	ON/OFF
Type: Burst N Cycle		
Source: INT		
Trigger Out: Rise		
Phase: 0.0 °		
Cycles: 1 Cyc		
Period: 10.000mSec		
Delay: 0.00 uSec		

5. SECONDARY SYSTEM FUNCTION SETTINGS

The secondary system functions are used to store and recall settings, view help files, view the software version, update the firmware, set the buzzer.

5-1. Save and Recall

The FGX-2220 has non-volatile memory to store instrument state and ARB data. There are 10 memory files numbered 0~9. Each memory file can either store arbitrary waveform data (ARB), settings or both. When data (ARB or Setting data) is stored in a memory file, the data will be shown in red. If a file has no data, it will be shown in blue.

Save/Recall Properties	ARB
	<ul style="list-style-type: none"> • Rate • Frequency • Length • Display horizontal
	<ul style="list-style-type: none"> • Display vertical • Output Start • Output length
	Setting
	<ul style="list-style-type: none"> • Functions <ul style="list-style-type: none"> • Waveform • Frequency • Pulse Width • Square wave Duty • Ramp Symmetry • Amplitude • Amplitude unit • Offset • Modulation type • Beep setting • Impedance • Main output • Sweep <ul style="list-style-type: none"> • Source • Type • Marker • Time • Start frequency
	<ul style="list-style-type: none"> • AM <ul style="list-style-type: none"> • Source • Shape • Depth • AM frequency • FM <ul style="list-style-type: none"> • Source • Shape • Deviation • FM frequency • FSK <ul style="list-style-type: none"> • Source • Shape • PM <ul style="list-style-type: none"> • Rate • Hop frequency • Source • Shape • Phase deviation

- Stop frequency
- Center frequency
- Span frequency
- Marker frequency
- Frequency
- Burst Type
- Source
- Trigger out
- Type
- Cycles
- Phase
- Period
- Delay

Panel Operation

1. Press the UTIL key.



2. Press F1 (Memory).



3. Use the scroll wheel to highlight a memory file number.

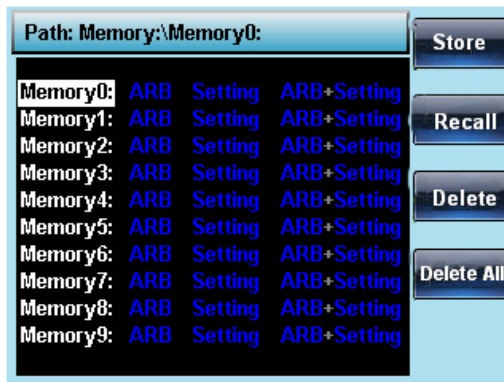
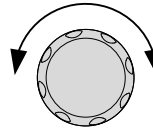

4. Choose a file operation:

Press F1 to store a file, press F2 to recall a file, or press F3 to delete a file.



- Use the scroll wheel to highlight the data type.

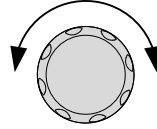

ARB, Setting or ARB+Setting

- Press F5 (Done) to choose the data type.



Range	Memory file	Memory0 ~ Memory9
	Data type	ARB, Setting, ARB+Setting

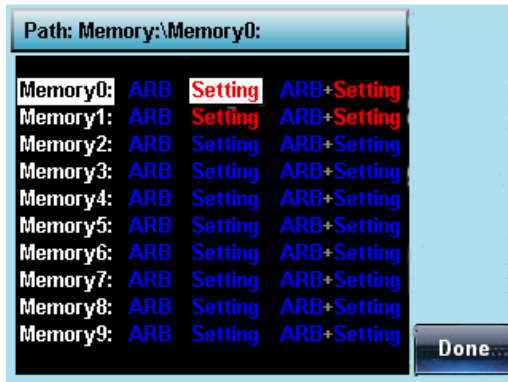

- Press F5 (Done) to confirm the operation.



Delete All

- To delete all the files for Memory0~Memory9, press F4.









- Press F1 (Done) to confirm the deletion of all files.







5-2. System and Settings

There are a number of miscellaneous settings and firmware settings that can be configured.

5-2-1. Viewing and Updating the Firmware

- View Version
1. Press the UTIL key. 
 2. Press F2 (Cal.).  
 3. Press F2 (Software).  
 4. Press F1 (Version) to view the firmware version.  

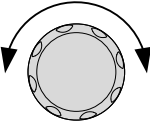
The version information will be shown on screen:
Instrument, Version, FPGA Revision

- Update Firmware
5. To update the firmware, insert a USB flash drive with a firmware file in the USB host drive. Press F2 (Upgrade).  
 6. Use the scroll wheel to highlight the firmware file. Press F1(Select)   
-





Note

The firmware file (*.bin) must be located in a directory, directly off the USB root directory.

5-2-2. Setting the Buzzer Sound

Background Turns the beeper on or off.

- Panel Operation
1. Press the UTIL key. 
 2. Press F3 (System).  

3. Press F3 (Beep) to toggle the buzzer sound on or off.



4. Press F1(ON) or Press F2(OFF)

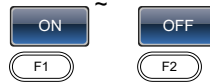

5-2-3. Frequency Counter

Example: Turn on the frequency counter. Gate time: 1 second.

Output: N/A

1. Press UTIL, F5 (Counter).



Input:

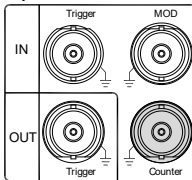

2. Press F1 (Gate Time), and press F3 (1 Sec) to choose a gate time of 1 second.





3. Connect the signal of interest to the Frequency counter input on the rear panel.

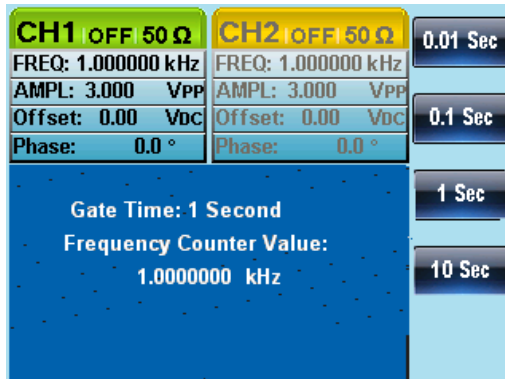

4. Input a 1kHz square wave signal into the Counter input on the rear panel. Set the gate time to 1S.





5-3. Dual channel Settings

5-3-1. Frequency Coupling

1. Press UTIL, F4 (Dual Chan) to enter the coupling function.  





2. Press F1 (Freq Cpl) to select the frequency coupling function.  

3. Press F2 (Offset). The offset is the frequency difference between CH1 and CH2. Use the number keys or scroll wheel to enter the offset.  

There are two different coupling modes. They are calculated as follows:

$$\text{Offset} = \text{CH2} - \text{CH1}$$

$$\text{Ratio} = \text{CH2} / \text{CH1}$$

4. Input an offset value of 1kHz.   ~
Press F1~ F5 to select the units.  



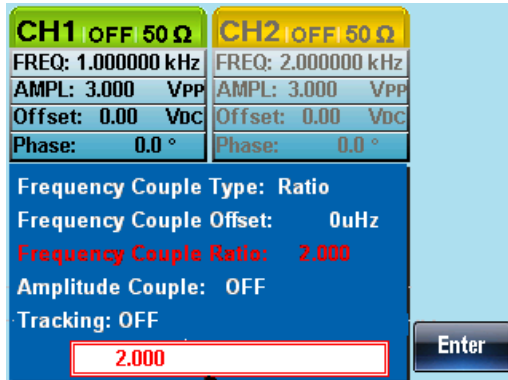

The frequency of channel 2 becomes 2kHz (CH2=CH1 + Offset).

CH1 OFF 50 Ω	CH2 OFF 50 Ω	uHz
FREQ: 1.000000 kHz	FREQ: 2.000000 kHz	
AMPL: 3.000 VPP	AMPL: 3.000 VPP	mHz
Offset: 0.00 Vdc	Offset: 0.00 Vdc	
Phase: 0.0 °	Phase: 0.0 °	Hz
Frequency Couple Type: Offset		
Frequency Couple Offset: 1.0000 kHz		
Frequency Couple Ratio: 1.000		kHz
Amplitude Couple: OFF		
Tracking: OFF		MHz
1.00000000 kHz		

- Change the frequency coupling mode to Ratio. Set the ratio to 2.
The frequency of CH2 automatically changes accordingly to match the ratio (CH2=CH1*Ratio).





5-3-2. Amplitude Coupling

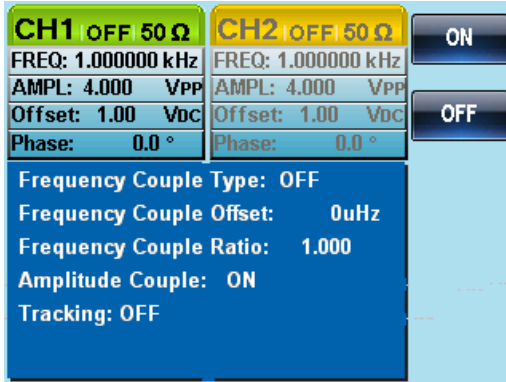

- The following assumes that the amplitude has already been set to 4Vpp with a DC offset of 1Vdc.
- Press UTIL, F4 (Dual Chan) to enter the coupling function.
 

- Press F2 (Ampl Cpl), F1 (ON) to select the amplitude coupling function.
 

- The amplitude and offset between both channel is coupled. Any changes in amplitude in the current channel is reflected in the other channel.



5-3-3. Tracking

1. The method for outputting a square wave has been previously described. Use this method to output a 2kHz squarewave from CH1 with an amplitude of 5Vpp and a DC offset of 1Vdc.

2. Press UTIL, F4 (Dual Chan) to enter the coupling function.  

3. Press F3 (Tracking), F2 (On) to turn on the tracking function.  

4. When tracking is turned on, parameters such as amplitude and frequency from the current channel are mirrored on the other channel.

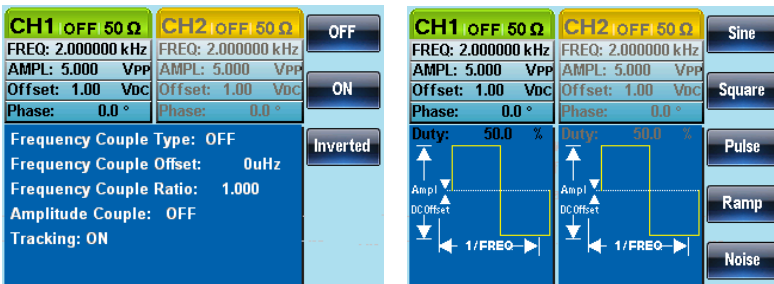

6. CHANNEL SETTINGS

The channel settings chapter shows how to set the output impedance, output phase and DSO connection settings.

6-1. Output Impedance





Background The FGX-2220 has selectable output impedances: 50Ω or high impedance. The default output impedance is 50Ω. The output impedances are to be used as a reference only. If the actual load impedance is different to that specified, then the actual amplitude and offset will vary accordingly.

Panel Operation 1. Press the CH1/CH2 key. 

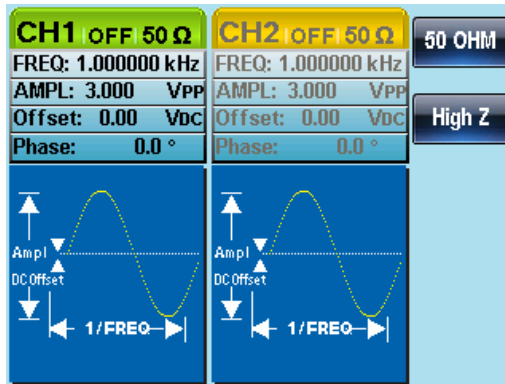
Note The load function can only be used if the ARB, MOD, SWEEP or BURST functions are not active.

2. Press F1 (Load).  





3. Select F1 (50 OHM) or F2 (High Z) to select the output impedance.  
 

6-2. Selecting the Output Phase

Panel operation 1. Press the CH1/CH2 key. 

Note The phase function can only be used if the ARB, MOD, SWEEP or BURST functions are not active.

2. Press F4 (Phase) and then press F1 (Phase)  

 

3. The Phase parameter in the parameter window will become highlighted.

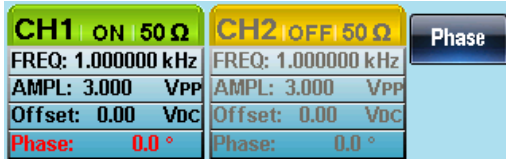

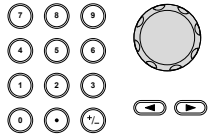

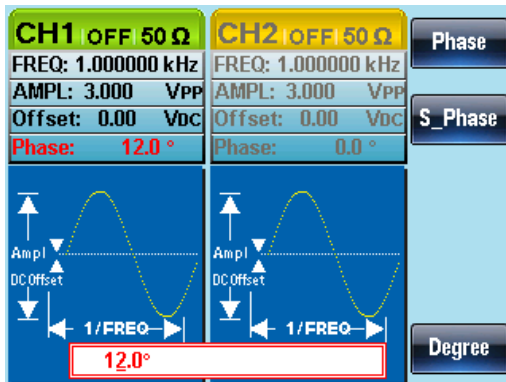

4. Use the arrow keys and scroll wheel or number pad to enter the output phase. 

5. Press F5 (Degree).  



6-3. Synchronizing the Phase

Background Synchronizes both the outputs on the FGX-2220.

- Panel Operation**
1. Press the CH1/CH2 key. 
 2. Press F4 (Phase).  
 3. Press F2 (S_Phase) to synchronize the phase of the channels.  



6-4. DSO Link

Background DSO Link enables the FGX-2220 to receive lossless data from a TEXIO DCS-7500A Series DSO to create ARB data.

Connection with other oscilloscopes is not possible. After processing the waveform data, save it to a USB flash disk and load it into the FGX-2220.

Connect the FGX-2220 USB host port to the DCS-7500A's USB B device port.



- Panel Operation**
1. Press the CH1/CH2 key. 
 2. Press F5 (DSO Link).  

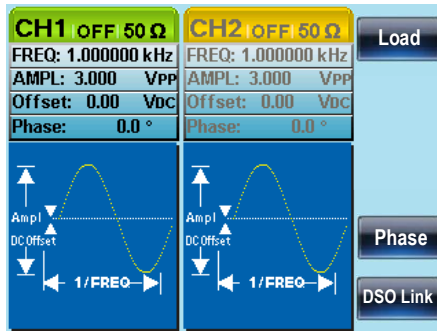

3. Press F1 (Search).



4. The “DCS Find” will be displayed.



5. To select a DSO channel, Press F2 (CH1), F3 (CH2), F4 (CH3) or F5 (CH4). The acquired data can then be displayed.

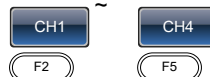

7. ARBITRARY WAVEFORMS

The FGX-2220 can create user-defined arbitrary waveforms with a sample rate of 120MHz. Each waveform can include up to 4k of data points with a vertical range of ± 511 .

7-1. Inserting Built-In Waveforms

The FGX-2220 includes 66 common waveforms, such as math waveforms, windowing functions and engineering waveforms.

7-1-1. Create an AbsAtan Waveform

Panel Operation

1. Press the ARB key.



2. Press F3(Built in).



3. Press F4(Wave).



4. Press F1(Common).



5. Use the scroll wheel to select “AbsAtan” from the built-in Common waveforms.



6. Press F5(Select) to select AbsAtan waveform



7. Press F1(Start) and set the start position of the AbsAtan waveform.



8. You can also change the length and scale of the waveform by pressing F2(Length) or F3(Scale).

Length

F2

Scale

F3
9. Press F5 (Done) to complete the operation

Done

F5
10. Press return to return to the previous menu.

Return

Below an Absatan wave created at start:0, Length: 33, Scale: 511

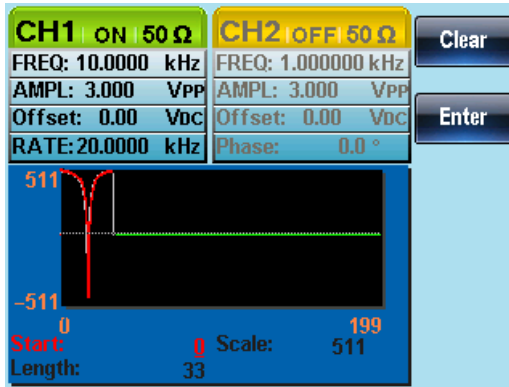

7-1-2. Built-in Waveform

COMMON	Absatan	Abssin	Abssinharf	Ampalt
	Attalt	Diric_even	Diric_odd	Gauspuls
	Harvercosin	Harversine	N_pulse	Negramp
	Rectpuls	Roundharf	Sawtoot	Sinetra
	Stair_ud	Stair_up	Stepwsp	Trapezia
	Tripuls			
	Math	Arccos	Arccot	Arccsc
Arcsin		Arcsinh	Arctan	Arctanh
Cosh		Cot	Csc	Dlorentz
Expofall		Exporise	Gauss	Ln
Lorentz		Sec	Sech	Sinec
Sinh		Sqrt	Tan	Tanh
Window		Barthannwin	Bartlett	Blackman
	Cherbyshev	Flattopwin	Hamming	Hann
	Hanning	Kaiser	Triang	Tukeywin
Engineer	Airy	Bessel	Betainc	Gamma
	Legendre	Neumann		

7-2. Display an Arbitrary Waveform

7-2-1. Set the Horizontal Display Range

The horizontal window bounds can be set in one of two ways: Using a start point and length, or a center point and length.

Panel Operation

1. Press the ARB key.



2. Press F1 (Display) to enter the display menu.



3. Press F1 (Horizon) to enter the horizontal menu.



Using a Start Point

4. Press F1(Start)



5. The H_From parameter will become highlighted.



6. Use the arrow keys and scroll wheel or number pad to enter the H_From value.

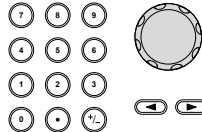

7. Press Clear (F1) to cancel.



8. Press F2 (Enter) to save the settings.



9. Press Return to return to the previous menu.



Setting the Length

10. Repeat steps 4~9 for Length (F2).



Using a Center Point

11. Repeat steps 4~9 for Center (F3).



Zoom in

12. To zoom into the arbitrary waveform, press F4 (Zoom In). The Zoom In function will reduce the length by half each time the function is used. The minimum allowable length is 3.



Zoom out

13. To zoom out from the center point of the waveform, press F5 (Zoom out). The Zoom out function will increase the length by 2. The maximum allowable length is 4096.



Below, an arbitrary waveform has a start of 0, length of 200 and is centered at 100.



7-2-2. Set the Vertical Display Properties

Like the horizontal properties, the vertical display properties of the waveform display can be created in two ways: Setting high and low values, or setting the center point.

Panel Operation

1. Press the ARB key.



2. Press F1 (Display).



3. Press F2 (Vertical).



Setting the Low Point

4. Press F1 (Low).



5. The V_Low parameter will become highlighted.

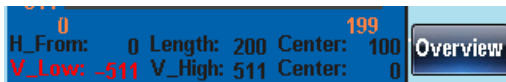

6. Use the arrow keys and scroll wheel or number pad to enter the V_Low value.

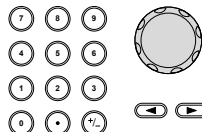

7. Press Clear (F1) to cancel.



8. Press F2 (Enter) to save the settings.



9. Press Return to return to the previous menu.



Setting the High Point

10. Repeat steps 4~9 for V_High (F2).



Setting the Center Point

11. Repeat steps 4~9 for Center (F3).



Zoom

12. To zoom in from the center of the arbitrary waveform, press F4 (Zoom in). The Zoom in function will reduce the length by half each time the function is used. The minimum allowable vertical low is -2, and the minimum vertical high is 2.



13. To zoom out of the waveform, press F5 (Zoom out). The Zoom out function will increase the length by 2. The Vertical low maximum can be set to -511 and the vertical high maximum can be set to +511.



Below, the AbsAtan wave is with a vertical low of -511, a vertical high 511 and a center of 0.

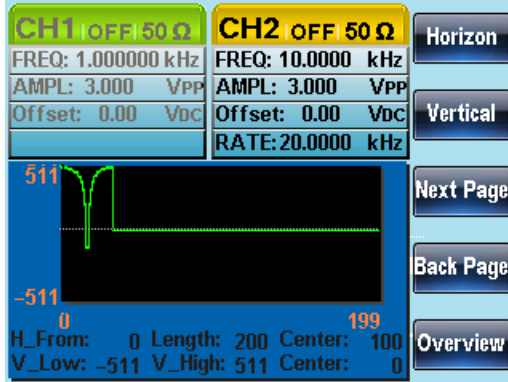

7-2-3. Page Navigation (Back Page)

Background When viewing the waveform, the display window can be moved forward and backward using the Next/Back Page functions.

Panel Operation

1. Press the ARB key.



2. Press F1 (Display).



3. Press F4 (Back Page) to move the display window one view length backward.



$H_From^* = H_From - Length$
 $Center^* = Center - Length$
 $*Length \text{ until } 0$



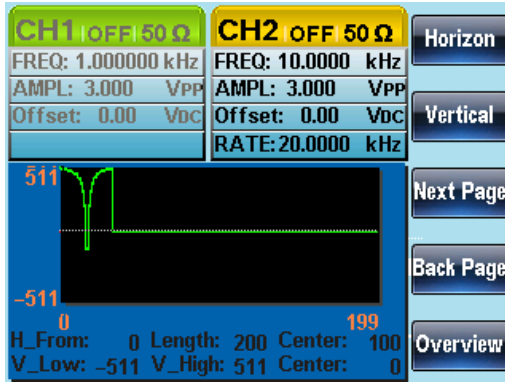
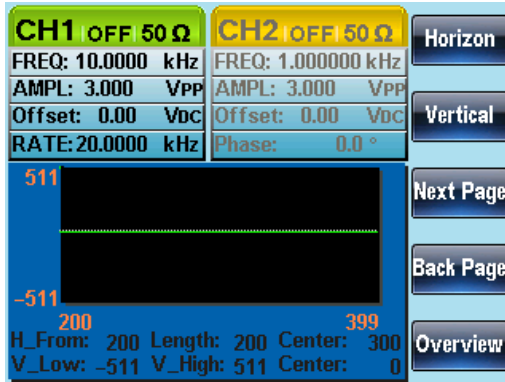

Below, shows the display after Back Page has been pressed.

H_From: 200 → 0
 Length: 200
 Center: 300 → 100



7-2-4. Page Navigation (Next Page)

Background When viewing the waveform, the display window can be moved forward and backward using the Next/Back Page functions.

- Panel Operation**
1. Press the ARB key. 
 2. Press F1 (Display).  
 3. Press F3 (Next Page) to move the display window one view length forward.  

$H_From^* = H_From + Length$
 $Center = Center + Length$
 $*H_From + Length \leq 4096$

Below, shows the display after Next Page has been pressed.

H_From: 0 → 200
 Length: 200
 Center: 100 → 300

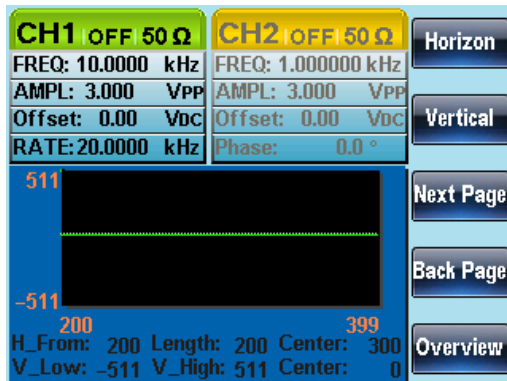
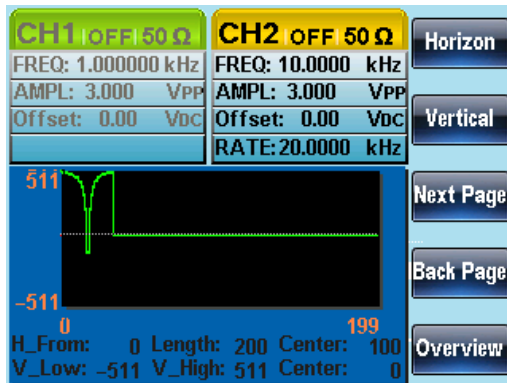

7-2-5. Display

Panel Operation 1. Press the ARB key.



2. Press F1 (Display).



To make the display window cover the whole waveform, press F5 (Overview).



Horizontal: 0~4095
Vertical: 511~ -511

Below shows the display after Overview has been selected.

H_From: 0 → 0
Length: 400→4096
Center:200→ 2048
Vertical low/high: ±511

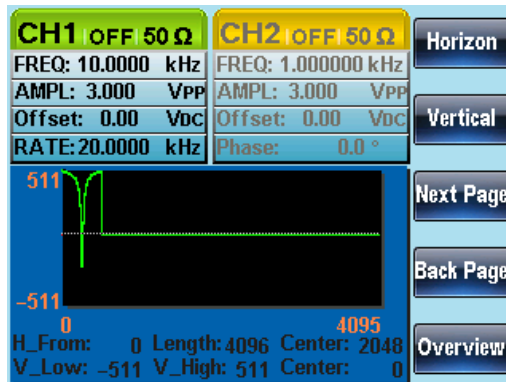

7-3. Editing an Arbitrary Waveform

7-3-1. Adding a Point to an Arbitrary Waveform

Background The FGX-2220 has a powerful editing function that allows you to create points or lines anywhere on the waveform.

Panel Operation 1. Press the ARB key.



2. Press F2 (Edit).



3. Press F1 (Point).



4. Press F1 (Address).



5. The Address parameter becomes highlighted.



6. Use the arrow keys and scroll wheel or number pad to enter the Address value.

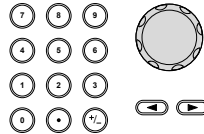

7. Press F2 (Enter) to save the settings.



8. Press Return to return to the previous menu.



9. Press F2 (Data).



10. The Data parameter will become highlighted.

11. Use the selector keys and scroll wheel or number pad to enter a Data value.

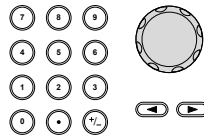

12. Press F2 (Enter) to save the settings.



13. Press Return to return to the previous menu.



14. Press return again to go back to the ARB menu.



In the following figure the edited address is shown in red.



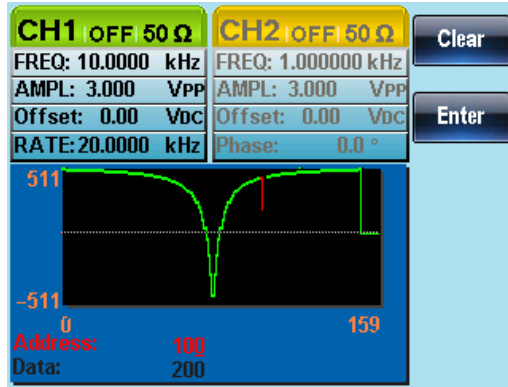



Address 100, Data 200



7-3-2. Adding a Line to an Arbitrary Waveform

Background The FGX-2220 has a powerful editing function that allows you to create points or lines anywhere on the waveform.

Panel Operation

1. Press the ARB key. 
2. Press F2 (Edit).  
3. Press F2 (Line).  
4. Press F1 (Start ADD).  
5. The Start Address parameter will be highlighted in red.



6. Use the arrowkeys keys and scroll wheel or number pad to enter the start address.

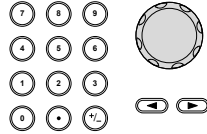

7. Press F2 (Enter) to save the settings.



8. Press Return to return to the previous menu.



9. Repeat steps 4~8 for Start Data (F2), Stop Address (F3) and Stop Data (F4).

10. Press F5 (Done) to confirm the line edit.



11. Press Return to return to the previous menu.



The red line was created below with the following properties:

Start Address: 0, Start Data: 0

Stop Address: 32, Stop Data: 0

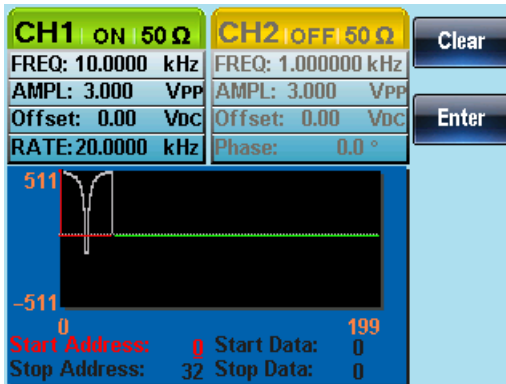

7-3-3. Copy a Waveform

Panel Operation 1. Press the ARB key.



2. Press F2 (Edit).



3. Press F3 (Copy).



4. Press F1 (Start).



5. The Copy From properties will become highlighted in red.



6. Use the arrow keys and scroll wheel or number pad to enter the Copy From address.

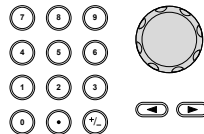

7. Press F2 (Enter) to save the settings.



8. Press Return to return to the previous menu.



9. Repeat steps 4~8 for Length (F2) and Paste To (F3).

10. Press F5 (Done) to confirm the selection.



11. Press Return to return to the previous menu.



A section of the waveform from points 0~33 was copied to points 50~83:

Copy From: 0
Length: 33
To: 50

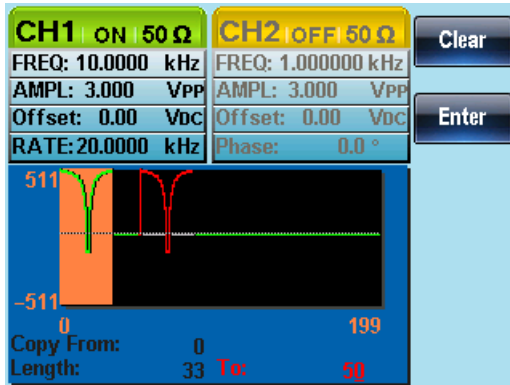

7-3-4. Clear the Waveform

Panel Operation

1. Press the ARB key.



2. Press F2 (Edit).



3. Press F4 (Clear).



4. Press F1 (Start).



5. The Clear From properties will become highlighted in red.



6. Use the arrow keys and scroll wheel or number pad to enter the Clear From address.

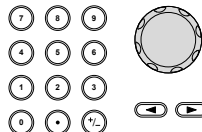

7. Press F2 (Enter) to save the settings.



8. Press Return to return to the previous menu.



9. Repeat steps 4~8 for Length (F2).



10. Press F3 (Done) to clear the selected section of the arbitrary waveform.



Delete All

11. Press F4 (ALL) to delete the whole waveform.



12. Press F1 (Done) again to confirm the deletion.



13. Press Return return to the previous menu.



Clear From: 20, Length: 33.



The same area after being cleared:

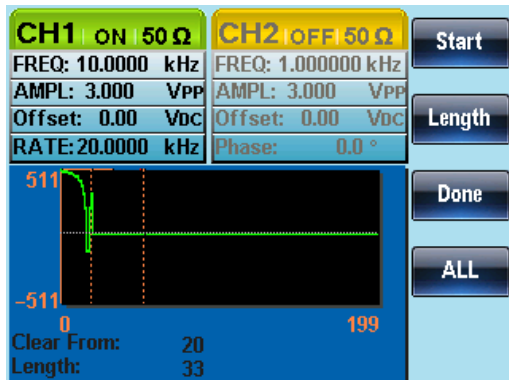

The result after the whole waveform is deleted:

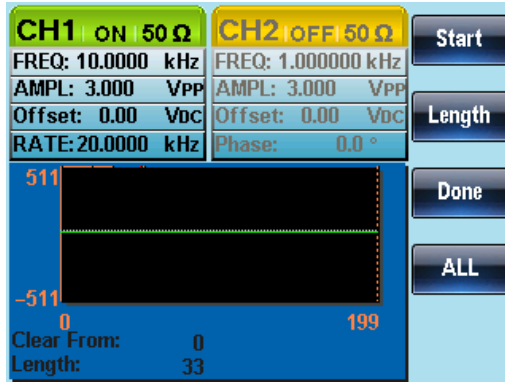

7-3-5.ARB Protection

The protection function designates an area of the arbitrary waveform that cannot be altered.

Panel Operation 1. Press the ARB key.



2. Press F2 (Edit).



3. Press F5 (Protect).



4. Press F2 (Start).



5. The Protect Start properties will become highlighted in red.



6. Use the arrow keys and scroll wheel or number pad to enter the Protect Start address.

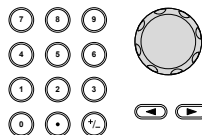

7. Press F2 (Enter) to save the settings.



8. Press Return to return to the previous menu.

9. Repeat steps 4~8 for Length (F3).

10. Press F4 (Done) to confirm the protected area.

Protect All 11. Press F1 (ALL) to protect the whole waveform.

12. Press F1 (Done) to confirm.

Unprotect All 13. Press F5 (Unprotect) to unprotect the whole waveform.

14. Press F1 (Done) to confirm.

15. The waveform background will return back to black. The property "Protect Off" will be grayed out.

Below, the protected areas of the waveform are shown with an orange background:

Start:0, Length: 100.



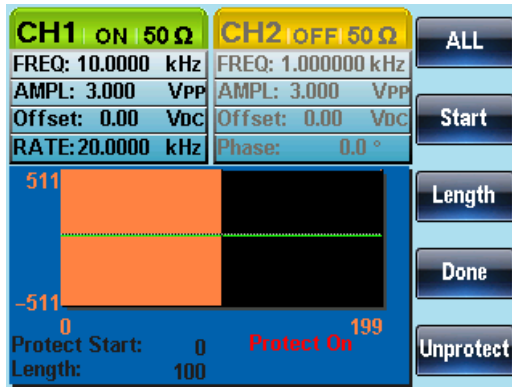

7-4. Output an Arbitrary Waveform

The arbitrary waveform generator can output up to 4k points (2~4096).

7-4-1. Output Arbitrary Waveform

Panel Operation 1. Press the ARB key.



2. Press F4 (Output).



3. Press F1 (Start).



4. The Start property will become highlighted in red.



5. Use the arrow keys and scroll wheel or number pad to enter the Start address.

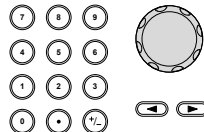

6. Press F2 (Enter) to confirm the start point.



7. Press Return to return to the previous menu.



8. Repeat steps 4~7 for Length (F2). Length
9. Press Return to return to the previous menu.

The front panel terminal will output the following waveform.

Start 0, Length 500

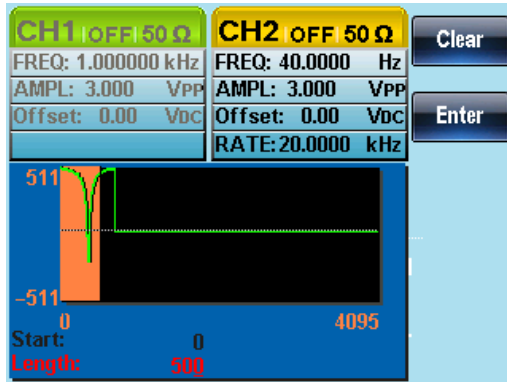

7-5. Saving/Loading an Arbitrary Waveform

The FGX-2220 can save and load arbitrary waveforms from 10 internal memory slots. Arbitrary waveforms can also be saved and loaded from a USB flash disk.

7-5-1. Saving a Waveform to Internal Memory

- Panel Operation
1. Press the ARB key.
 2. Press F5 (More). More
 3. Press F1 (Save). Save
 4. Press F1 (Start). Start
 5. The Start property will become highlighted in red.

6. Use the arrow keys and scroll wheel or number pad to enter the Start address.

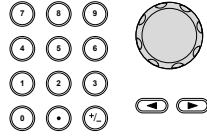

7. Press F2 (Enter) to confirm the start point.



8. Press Return to return to the previous menu.



9. Repeat steps 4~8 for Length (F2).



10. Press F3 (Memory).



11. Select a memory file using the scroll wheel.

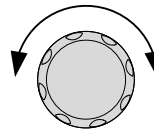

Memory0~Memory9

12. Press F1 (Select) to save the selected memory file.









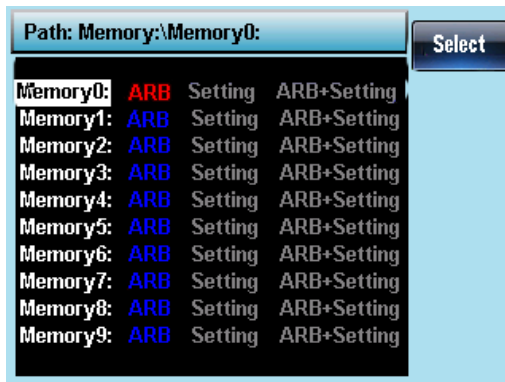



13. Press Return to return to the previous menu.

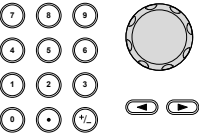

Below the file Memory0 is selected using the scroll wheel.

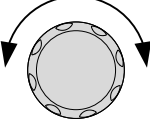

7-5-2. Saving a Waveform to USB flash disk

- Panel Operation
1. Press the ARB key. 
 2. Press F5 (More). 
 3. Press F1 (Save). 
 4. Press F1 (Start). 
 5. The Start property will become highlighted in red.
 6. Use the arrow keys and scroll wheel or number pad to enter the Start address. 
 7. Press F2 (Enter) to confirm the start point. 
 8. Press Return to return to the previous menu. 
 9. Repeat steps 4~8 for Length (F2). 
 10. Press F4 (USB). 
 11. Use the scroll wheel to navigate the file system. 
 12. Press Select to select directories or files. 
-

- Create a Folder
1. Press F2 (New Folder). 

2. The text editor will appear with a default folder name of "NEW_FOL".

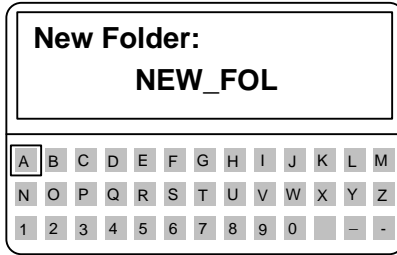

3. Use the scroll wheel to move the cursor.

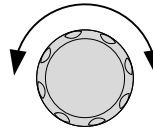

4. Use F1 (Enter Char) or F2 (Backspace) to create a folder name.



5. Press F5 (Save) to save the folder name.



Create a New File 1. Press F3 (New File).



2. The text editor will appear with a default file name of "NEW_FIL".

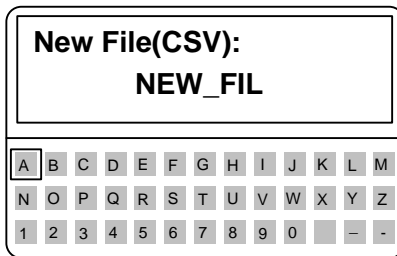

3. Use the scroll wheel to move the cursor.

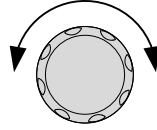

4. Use F1 (Enter Char) or F2 (Backspace) to create a file name.



5. Press F5 (Save) to save the file name.



Below the folder, BIN, has been created in the root directory.



7-5-3. Load a Waveform from Internal Memory

- Panel Operation 1. Press the ARBkey.



2. Press F5 (More).



3. Press F2 (Load).



4. Press F1 (Memory).



5. Use the scroll wheel to choose a memory file.

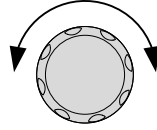

6. Press Select to load the selected memory file.



7. Press F3 (To) to choose the starting point for the loaded waveform.



8. The Load To parameter will become highlighted in red.



9. Use the selector keys and scroll wheel or number pad to enter the starting point.

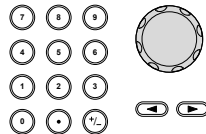

10. Press F2(Enter) to confirm the start point.



11. Press Return to return to the previous menu.



12. Press F4(Done).



Below the file Memory0 is selected using the scroll wheel loaded to position 0.



7-5-4. Load a Waveform from USB

Panel Operation 1. Press the ARB key.



2. Press F5 (More).



3. Press F2 (Load).



4. Press F2 (USB).



5. Use the scroll wheel to choose a file name.

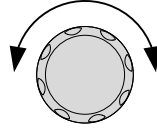

6. Press F1 (Select) to select the file to load.



7. Press F3 (To) to choose the starting point for the loaded waveform.



8. The Load To property will become highlighted in red.

9. Use the arrow keys and scroll wheel or number pad to enter the starting point.

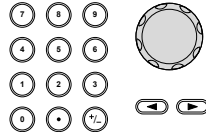

10. Press F2 (Enter) to confirm the Start point.



11. Press F4 (Done).



Below the file FGX.CSV is selected using the scroll wheel loaded to position 0.



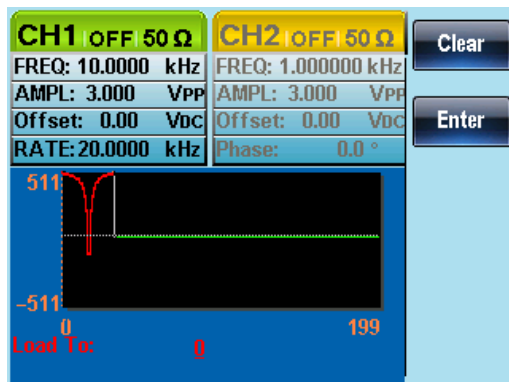

8. REMOTE INTERFACE

8-1. Establishing a Remote Connection

The FGX-2220 supports USB remote connections.

8-1-1. Configure USB interface

USB configuration	PC side connector	Type A, host
	FGX-2220 side connector	Type B, slave
	Speed	1.1/2.0 (full speed)
	Class	USB-CDC

- Panel Operation
1. Connect the USB cable to the rear panel USB B (slave) port. 
 2. When the PC requests for the USB driver, select XXXXXXXX.inf included in the software package or download the driver from our website, www.texio.co.jp
 3. If the PC can not recognize the new hardware due to the security, Please go to update the driver from the "Other device" in the Device Manager.

8-1-2. Remote control terminal connection

Terminal application Invoke the terminal application such as MTTY (Multi-Threaded TTY) or PuTTY. For USB, set the COM port, baud rate, stop bit, data bit, and parity accordingly.

To check the COM port No, see the Device Manager in the PC. For Windows, Control panel → System → Hardware tab.

Functionality check Run this query command via the terminal.

`*idn?`

This should return the Manufacturer, Model number, Serial number, and Firmware version in the following format.

TEXIO, FGX-2220, SN:XXXXXXXX, Vm.mm

Note: ^j or ^m can be used as the terminal character when using a terminal program.

PC Software

The proprietary PC software, downloadable from our website, can be used for remote control.

Display

When a remote connection is established all panel keys are locked bar F5.

1. Press REM/LOCK (F5) to return the function generator to local mode.

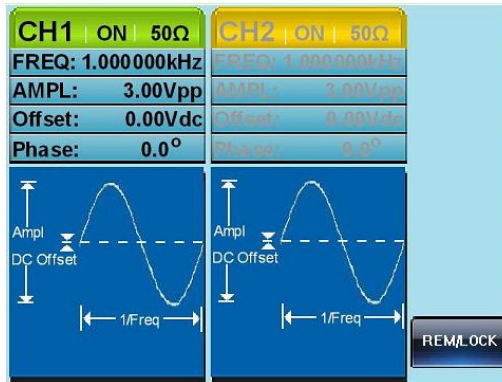

8-1-3. Command Syntax

Compatible standard

- IEEE488-1992 (fully compatible)
- SCPI, 1994 (partially compatible)

Command Tree

The SCPI standard is an ASCII based standard that defines the command syntax and structure for programmable instruments.

Commands are based on a hierarchical tree structure. Each command keyword is a node on the command tree with the first keyword as the root node. Each sub node is separated with a colon.

Shown below is a section of the `SOURCE[1|2]` root node and the `:PM` and `:PULSe` sub nodes.

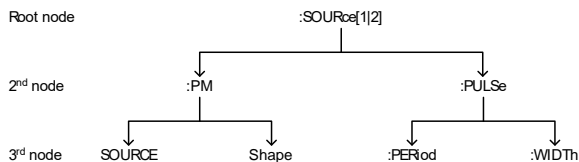

Command types	Commands can be separated in to three distinct types, simple commands, compound commands and queries.
Simple	A single command with/without a parameter
Example	*OPC
Compound	Two or more commands separated by a colon (:) with/without a parameter
Example	SOURce1:PULSe:WIDTh
Query	A query is a simple or compound command followed by a question mark (?). A parameter (data) is returned. The maximum or minimum value for a parameter can also be queried where applicable.
Example	SOURce1:FREQuency? SOURce1:FREQuency? MIN

Command forms Commands and queries have two different forms, long and short. The command syntax is written with the short form of the command in capitals and the remainder (long form) in lower case.

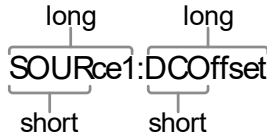

The commands can be written in capitals or lower-case, just so long as the short or long forms are complete. An incomplete command will not be recognized. Below are examples of correctly written commands:

LONG SOURce1:DCOffset
 SOURCE1:DCOFFSET
 source1:dcoffset

SHORT SOUR1:DCO
 sour1:dco

Command Format	SOURce1:DCOffset <offset>LF	1: command header
	1 2 3 4	2: single space
		3: parameter
		4: message terminator

Square Brackets [] Commands that contain squares brackets indicate that the contents are optional. The function of the command is the same with or without the square bracketed items. Brackets are not sent with the command.

For example, the frequency query below can use any of the following 3 forms:

SOURce1:FREQUency? [MINimum|MAXimum]

SOURce1:FREQUency? MAXimum

SOURce1:FREQUency? MINimum

SOURce1:FREQUency?

Braces {} Commands that contain braces indicate one item within the braces must be chosen. Braces are not sent with the command.

Angled Brackets <> Angle brackets are used to indicate that a value must be specified for the parameter. See the parameter description below for details. Angled brackets are not sent with the command.

Bars | Bars are used to separate multiple parameter choices in the command format.

Parameters	Type	Description	Example
	<Boolean>	Boolean logic	0, 1/ON,OFF
	<NR1>	integers	0, 1, 2, 3
	<NR2>	decimal numbers	0.1, 3.14, 8.5
	<NR3>	floating point	4.5e-1, 8.25e+1
	<NRf>	any of NR1, 2, 3	1, 1.5, 4.5e-1
	<NRf+> <Numeric>	NRf type with a suffix including MINimum, MAXimum or DEFault parameters.	1, 1.5, 4.5e-1 MAX, MIN,
	<aard>	Arbitrary ASCII characters.	
	<discrete>	Discrete ASCII character parameters	IMM, EXT, MAN
	<frequency> <peak deviation in Hz> <rate in Hz>	NRf+ type including frequency unit suffixes.	1 KHZ, 1.0 HZ, MHZ

	<amplitude>	NRf+ type including VPP voltage peak to peak.
	<offset>	NRf+ type including volt V unit suffixes.
	<seconds>	NRf+ type including NS, S MS US time unit suffixes.
	<percent> <depth in percent>	NRf type N/A
Message terminators	LF CR	line feed code (new line) and carriage return.
	LF	line feed code (new line)
	EOI	IEEE-488 EOI (End-Or-Identify)
 Note	^j or ^m should be used when using a terminal program.	
	Command Separators	
	Space	A space is used to separate a parameter from a keyword/command header.
	Colon (:)	A colon is used to separate keywords on each node.
	Semicolon (;)	A semi colon is used to separate subcommands that have the same node level. For example: SOURCE[1 2]:DCOffset? SOURCE[1 2]:OUTPut? →SOURCE1:DCOffset?;OUTPut?
	Colon + Semicolon (:;)	A colon and semicolon can be used to combine commands from different node levels. For example: SOURCE1:PM:SOURCE? SOURCE:PULSE:WIDTH? →SOURCE1:PM:SOURCE?::SOURCE:PULSE:WIDTH?
	Comma (,)	When a command uses multiple parameters, a comma is used to separate the parameters. For example: SOURCE:APPLY:SQUare 10KHZ, 2.0 VPP, -1V

8-2. Command List

8-3-1. SYSTem:ERRor?	133
8-3-2. *IDN?	133
8-3-3. *RST	133
8-3-4. SYSTem:VERSion?	134
8-3-5. *OPC	134
8-3-6. *OPC?	135
8-4-1. *CLS	135
8-4-2. *ESE	135
8-4-3. *ESR?	136
8-4-4. *STB?	136
8-4-5. *SRE	137
8-5-1. SYSTem:LOCAl	137
8-5-2. SYSTem:REMote	138
8-6-1. SOURce[1 2]:APPLy:SINusoid	139
8-6-2. SOURce[1 2]:APPLy:SQUare	140
8-6-3. SOURce[1 2]:APPLy:RAMP	140
8-6-4. SOURce[1 2]:APPLy:PULSe	141
8-6-5. SOURce[1 2]:APPLy:NOISe	141
8-6-6. SOURce[1 2]:APPLy:USER	142
8-6-7. SOURce[1 2]:APPLy?	142
8-7-1. SOURce[1 2]:FUNCTion	143
8-7-2. SOURce[1 2]:FREQUency	144
8-7-3. SOURce[1 2]:AMPlitude	145
8-7-4. SOURce[1 2]:DCOffset	146
8-7-5. SOURce[1 2]:SQUare:DCYCLE	147
8-7-6. SOURce[1 2]:RAMP:SYMMetry	147
8-7-7. OUTPut[1 2]	148
8-7-8. OUTPut[1 2]:LOAD	149
8-7-9. SOURce[1 2]:VOLTagE:UNIT	149
8-8-1. SOURce[1 2]:PULSe:PERiod	150
8-8-2. SOURce[1 2]:PULSe:WIDTh	151
8-9-1. AM Overview	152
8-9-2. SOURce[1 2]:AM:STATe	153
8-9-3. SOURce[1 2]:AM:SOURce	153
8-9-4. SOURce[1 2]:AM:INTernal:FUNCTion	154
8-9-5. SOURce[1 2]:AM:INTernal:FREQUency	154
8-9-6. SOURce[1 2]:AM:DEPTh	155
8-10-1. FM Overview	156
8-10-2. SOURce[1 2]:FM:STATe	156
8-10-3. SOURce[1 2]:FM:SOURce	157
8-10-4. SOURce[1 2]:FM:INTernal:FUNCTion	157
8-10-5. SOURce[1 2]:FM:INTernal:FREQUency	158
8-10-6. SOURce[1 2]:FM:DEVIation	159
8-11-1. FSK Overview	160
8-11-2. SOURce[1 2]:FSKey:STATe	160
8-11-3. SOURce[1 2]:FSKey:SOURce	161
8-11-4. SOURce[1 2]:FSKey:FREQUency	161
8-11-5. SOURce[1 2]:FSKey:INTernal:RATE	162

8-12-1. PM Overview	163
8-12-2. SOURce[1 2]:PM:STATe	163
8-12-3. SOURce[1 2]:PM:SOURce	164
8-12-4. SOURce[1 2]:PM:INTernal:FUNction	164
8-12-5. SOURce[1 2]:PM:INTernal:FREQuency	165
8-12-6. SOURce[1 2]:PM:DEVIation	166
8-13-1. SUM Overview	167
8-13-2. SOURce[1 2]:SUM:STATe	167
8-13-3. SOURce[1 2]:SUM:SOURce	168
8-13-4. SOURce[1 2]:SUM:INTernal:FUNction	168
8-13-5. SOURce[1 2]:SUM:INTernal:FREQuency	169
8-13-6. SOURce[1 2]:SUM:AMPL	169
8-14-1. Sweep Overview	171
8-14-2. SOURce[1 2]:SWEep:STATe	172
8-14-3. SOURce[1 2]:FREQuency:START	172
8-14-4. SOURce[1 2]:FREQuency:STOP	173
8-14-5. SOURce[1 2]:FREQuency:CENTEr	173
8-14-6. SOURce[1 2]:FREQuency:SPAN	174
8-14-7. SOURce[1 2]:SWEep:SPACing	175
8-14-8. SOURce[1 2]:SWEep:TIME	175
8-14-9. SOURce[1 2]:SWEep:SOURce	176
8-14-10. SOURce[1 2]:MARKer:FREQuency	177
8-14-11. SOURce[1 2]:MARKer	177
8-15-1. Burst Mode Overview	178
8-15-2. SOURce[1 2]:BURSt:STATe	179
8-15-3. SOURce[1 2]:BURSt:MODE	180
8-15-4. SOURce[1 2]:BURSt:NCYCles	180
8-15-5. SOURce[1 2]:BURSt:INTernal:PERiod	181
8-15-6. SOURce[1 2]:BURSt:PHASe	182
8-15-7. SOURce[1 2]:BURSt:TRIGger:SOURce	183
8-15-8. SOURce[1 2]:BURSt:TRIGger:DELay	184
8-15-9. SOURce[1 2]:BURSt:TRIGger:SLOPe	184
8-15-10. SOURce[1 2]:BURSt:GATE:POLarity	185
8-15-11. SOURce[1 2]:BURSt:OUTPut:TRIGger:SLOPe	185
8-15-12. OUTPut[1 2]:TRIGger	186
8-15-13. SOURce[1 2]:BURSt:TRIGger:MANual	187
8-16-1. Arbitrary Waveform Overview	187
8-16-2. SOURce[1 2]:FUNctioN USER	188
8-16-3. SOURce[1 2]:DATA:DAC	188
8-16-4. SOURce[1 2]:ARB:EDIT:COpy	189
8-16-5. SOURce[1 2]:ARB:EDIT:DELete	189
8-16-4. SOURce[1 2]:ARB:EDIT:DELete:ALL	190
8-16-7. SOURce[1 2]:ARB:EDIT:POINt	190
8-16-8. SOURce[1 2]:ARB:EDIT:LINE	190
8-16-9. SOURce[1 2]:ARB:EDIT:PROTEct	191
8-16-10. SOURce[1 2]:ARB:EDIT:PROTEct:ALL	191
8-16-11. SOURce[1 2]:ARB:EDIT:UNProtect	191
8-16-12. SOURce[1 2]:ARB:OUTPut	191
8-17-1. COUNTER:STATE	192
8-17-2. COUNter:GATE	192

8-17-3. COUNter:VALue?	193
8-18-1. SOURce[1 2]:PHASe	193
8-18-2. SOURce[1 2]:PHASe:SYNChronize	194
8-19-1.SOURce[1 2]:FREQuency:COUPle:MODE	194
8-19-2. SOURce[1 2]:FREQuency:COUPle:OFFSet	194
8-19-3. SOURce[1 2]:FREQuency:COUPle:RATio	195
8-19-4. SOURce[1 2]:AMPLitude:COUPle:STATe	195
8-19-5. SOURce[1 2]:TRACK	196
8-20-1. *SAV	197
8-20-2. *RCL	197
8-20-3. MEMory:STATe:DELeTe	197
8-20-4. MEMory:STATe:DELeTe ALL	197

8-3. System Commands

8-3-1. SYSTem:ERRor?

→ Query

Description	Reads an error from the error queue. See page 209 for details regarding the error queue.	
Query Syntax	SYSTem:ERRor?	
Return parameter	<string1><CR+LF> <string2>	Returns an error code and strings.
Example	SYSTem:ERRor? -138 <CR+LF>Suffix not allowed Returns an error code and string. Include CR, LF code.	

8-3-2. *IDN?

→ Query

Description	Returns the function generator manufacturer, model number, serial number and firmware version number in the following format: TEXIO,FGX-2220,SN:XXXXXXXX,Vm.mm
Query Syntax	*IDN?
Return parameter	<string>
Example	*IDN? TEXIO,FGX-2220,SN:XXXXXXXX,Vm.mm Returns the identification of the function generator.

8-3-3. *RST

Set →

Description	Reset the function generator to its factory default state.
Note	Note the *RST command will not delete instrument save states in memory.
Syntax	*RST

8-3-4. SYSTem:VERSIon?

→ Query

Description Performs a system version query. Returns a string with the instrument, firmware version, FPGA revision

Query Syntax **SYSTem:VERSIon?**

Return parameter	<string1><CR+LF><CR+LF>	Model & Firmware Version
	<string2><CR+LF><CR+LF>	FPGA Version
	<string3><CR+LF><CR+LF>	Serial Number
	<string4>	Mode

Example **SYST:VERS?**
 >FGX-2220 Version-x.xx_xxxx
 >
 >FPGA:xxxxxxxx
 >
 >SN: xxxxxxxx
 >
 >MODE:Plant Pattern
 >
 Returns the versions ,SN , MODE.

8-3-5. *OPC

Set →

Description This command sets the Operation Complete Bit (bit 0) of the Standard Event Status Register after the function generator has completed all pending operations. For the FGX-2220, the *OPC command is used to indicate when a sweep or burst has completed.

Note Before the OPC bit is set, other commands may be executed.

Syntax ***OPC**

8-3-6. *OPC?

→ Query

Description	Returns the OPC bit to the output buffer when all pending operations have completed. I.e. when the OPC bit is set.
Note	Commands cannot be executed until the *OPC? query has completed.
Query Syntax	*OPC?
Return parameter	1
Example	*OPC? 1 Returns a "1" when all pending operations are complete.

8-4. Status Register Commands

8-4-1. *CLS

Set →

Description	The *CLS command clears all the event registers, the error queue and cancels an *OPC command.
Syntax	*CLS

8-4-2. *ESE

Set →

Description	The Standard Event Status Enable command determines which events in the Standard Event Status Event register can set the Event Summary Bit (ESB) of the Status Byte register. Any bit positions set to 1 enable the corresponding event. Any enabled events set bit 5 (ESB) of the Status Byte register.
Note	The *CLS command clears the event register, but not the enable register.
Syntax	*ESE <enable value>
Parameter	<enable value> 0~255
Example	*ESE 20 Sets a bit weight of 20 (bits 2 and 4).
Query Syntax	*ESE?

Return Parameter	Bit	Register	Bit	Register
	0	Not used	4	Message Available
	1	Not used	5	Standard Event
	2	Error Queue	6	Master Summary
	3	Questionable Data	7	Not used

Example ***ESE?**
4
Bit 2 is set.

8-4-3. *ESR?

→ Query

Description Reads and clears the Standard Event Status Register. The bit weight of the standard event status register is returned.

Note The *CLS will also clear the standard event status register.

Query Syntax ***ESR?**

Return Parameter	Bit	Register	Bit	Register
	0	Operation Complete	4	Execution Error
	1	Not Used	5	Command Error
	2	Query Error	6	Not Used
	3	Device Error	7	Power On

Query Example ***ESR?**
5
Returns the bit weight of the standard event status register (bit 0 and 2).

8-4-4. *STB?

→ Query

Description Reads the Status byte condition register.

Note Bit 6, the master summary bit, is not cleared.

Syntax ***STB?**

8-4-5. *SRE

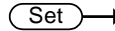

Description	The Service Request Enable Command determines which events in the Status Byte Register are allowed to set the MSS (Master summary bit). Any bit that is set to “1” can cause the MSS bit to be set.			
Note	The *CLS command clears the status byte event register, but not the enable register.			
Syntax	*SRE <enable value>			
Parameter	<enable value>	0~255		
Example	*SRE 12 Sets a bit weight of 12 (bits 2 and 3) for the service request enable register.			
Query Syntax	*SRE?			
Return Parameter	Bit	Register	Bit	Register
	0	Not used	4	Message Available
	1	Not used	5	Standard Event
	2	Error Queue	6	Master Summary
	3	Questionable Data	7	Not used
Query Example	*SRE? 12 Returns the bit weight of the status byte enable register.			

8-5. System Remote Commands

8-5-1. SYSTem:LOCAl

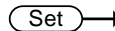

Description	Sets the function generator to local mode. In local mode, all front panel keys are operational.			
Syntax	SYSTem:LOCAl			
Example	SYST:LOC			

8-5-2. SYSTem:REMOte

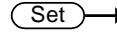

Description	Disables the front panel keys and puts the function generator into remote mode
Syntax	SYSTem:REMOte
Example	SYST:REM

8-6. Apply Commands

The APPLy command has 5 different types of outputs (Sine, Square, Ramp, Pulse, Noise,). The command is the quickest, easiest way to output waveforms remotely. Frequency, amplitude and offset can be specified for each function.

As only basic parameters can be set with the Apply command, other parameters use the instrument default values.

The Apply command will set the trigger source to immediate and disable burst, modulation and sweep modes. Turns on the output commandOUTPut[1|2] ON. The termination setting will not be changed.

As the frequency, amplitude and offset parameters are in nested square brackets, amplitude can only be specified if the frequency has been specified and offset can only be specified if amplitude has been set. For the example:

```
SOURce[1|2]:APPLy:SINusoid [<frequency> [,<amplitude> [,<offset>] ]]
```

Output Frequency For the output frequency, MINimum, MAXimum and DEFault can be used. The default frequency for all functions is set to 1 kHz. The maximum and minimum frequency depends on the function used. If a frequency output that is out of range is specified, the max/min frequency will be used instead. A "Data out range error will be generated" from the remote terminal.

Output Amplitude When setting the amplitude, MINimum, MAXimum and DEFault can be used. The range depends on the function being used and the output termination (50Ω or high impedance). The default amplitude for all functions is 100 mVpp (50Ω).

If the amplitude has been set and the output termination is changed from 50Ω to high impedance, the amplitude will double. Changing the output termination from high impedance to 50Ω will half the amplitude.

Vrms, dBm or Vpp units can be used to specify the output unit to use with the current command. The VOLT:UNIT command can be used to set the units when no unit is specified with the Apply command. If the output termination is set to high impedance, dBm units cannot be used. The units will default to Vpp.

The output amplitude can be affected by the function and unit chosen. Vpp and Vrms or dBm values may have different maximum values due to differences such as crest factor. For example, a 5Vrms square wave must be adjusted to 3.536 Vrms for a sine wave.

DC Offset voltage The offset parameter can be set to MINimum, MAXimum or DEFault. The default offset is 0 volts. The offset is limited by the output amplitude as shown below.

$$|V_{offset}| < V_{max} - V_{pp}/2$$

If the output specified is out of range, the maximum offset will be set.

The offset is also determined by the output termination (50Ω or high impedance). If the offset has been set and the output termination has changed from 50Ω to high impedance, the offset will double. Changing the output termination from high impedance to 50Ω will half the offset.

8-6-1. SOURce[1|2]:APPLy:SINusoid

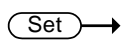

Description	Outputs a sine wave from the selected channel when the command has executed. Frequency, amplitude and offset can also be set.
Syntax	SOURce[1 2]:APPLy:SINusoid [<frequency> [,<amplitude> [,<offset>]]]

Parameter	<frequency> <amplitude> <offset>	1μHz~25MHz 1mVpp~10Vpp (50Ω) (3.536 Vrms) -4.99V~4.99V (50Ω)
Example	SOUR1:APPL:SIN 2KHZ,MAX,MAX Sets frequency to 2kHz and sets the amplitude and offset to the maximum.	

8-6-2. SOURce[1|2]:APPLy:SQUare

(Set) →

Description	Outputs a square wave from the selected channel when the command has executed. Frequency, amplitude and offset can also be set. The duty cycle is set to 50%.	
Syntax	SOURce[1 2]:APPLy:SQUare [<frequency> [,<amplitude> [,<offset>]]]	
Parameter	<frequency> <amplitude> <offset>	1μHz~25MHz 1mVpp~10Vpp (50Ω) -4.99V~4.99V (50Ω)
Example	SOUR1:APPL:SQU 2KHZ,MAX,MAX Sets frequency to 2kHz and sets the amplitude and offset to the maximum.	

8-6-3. SOURce[1|2]:APPLy:RAMP

(Set) →

Description	Outputs a ramp wave from the selected channel when the command has executed. Frequency, amplitude and offset can also be set. The symmetry is set to 50%.	
Syntax	SOURce[1 2]:APPLy:RAMP [<frequency> [,<amplitude> [,<offset>]]]	
Parameter	<frequency> <amplitude> <offset>	1μHz~1MHz 1mVpp~10Vpp (50Ω) -4.99V~4.99V (50Ω)
Example	SOUR1:APPL:RAMP 2KHZ,MAX,MAX Sets frequency to 2kHz and sets the amplitude and offset to the maximum.	

8-6-4. SOURce[1|2]:APPLy:PULSe

(Set) →

Description	Outputs a pulse waveform from the selected channel when the command has executed. Frequency, amplitude and offset can also be set.	
Note	<p>The PW settings from the SOURce[1 2]:PULS: WIDT command are preserved. Edge and pulse width may be adjusted to supported levels.</p> <p>Repetition rates will be approximated from the frequency. For accurate repetition rates, the period should be adjusted using the SOURce[1 2]:PULS:PER command</p>	
Syntax	SOUR[1 2]:APPLy:PULSe [<frequency> [,<amplitude> [,<offset>]]]	
Parameter	<frequency>	500μHz~25MHz
	<amplitude>	1mVpp~10Vpp (50Ω)
	<offset>	-4.99V~4.99V (50Ω)
Example	SOUR1:APPL:PULS 1KHZ,MIN,MAX	
	Sets frequency to 1kHz and sets the amplitude to minimum and the offset to the maximum.	

8-6-5. SOURce[1|2]:APPLy:NOISe

(Set) →

Description	Outputs Gaussian noise. Amplitude and offset can also be set.	
Note	Frequency cannot be used with the noise function; however a value (or DEFault) must be specified. The frequency is remembered for the next function used.	
Syntax	SOURce[1 2]:APPLy:NOISe [<frequency DEFault> [,<amplitude> [,<offset>]]]	
Parameter	<frequency>	Not applicable
	<amplitude>	1mVpp~10Vpp (50Ω)
	<offset>	-4.99V~4.99V (50Ω)
Example	SOUR1:APPL:NOIS DEF, 3.0, 1.0	
	Sets the amplitude to 3 volts with an offset of 1 volt.	

8-6-6. SOURce[1|2]:APPLy:USER

Set →

Description	Outputs an arbitrary waveform from the selected channel. The output is that specified from the FUNC:USER command.	
Note	Frequency and amplitude cannot be used with the DC function; however a value (or DEFault) must be specified. The values are remembered for the next function used.	
Syntax	SOURce[1 2]:APPLy:USER [<frequency> [,<amplitude> [,<offset>]]]	
Parameter	<frequency>	1μHz~60MHz
	<amplitude>	1mVpp~10Vpp (50Ω)
	<offset>	-4.99V~4.99V (50Ω)
Example	SOUR1:APPL:USER	

8-6-7. SOURce[1|2]:APPLy?

→ Query

Description	Outputs a string with the current settings.	
Note	The string can be passed back appended to the Apply Command.	
Syntax	SOURce[1 2]:APPLy?	
Return Parameter	<string>	Function, frequency, amplitude, offset
Example	SOUR1:APPL?	

SIN +5.000000000000E+03,+3.0000E+00,-2.50E+00

Returns a string with the current function and parameters, Sine, 5kHz, 3 Vpp, -2.5V offset.

8-7. Output Commands

Unlike the Apply commands, the Output commands are low level commands to program the function generator.

This section describes the low-level commands used to program the function generator. Although the APPLy command provides the most straightforward method to program the function generator, the low-level commands give you more flexibility to change individual parameters.

8-7-1. SOURce[1|2]:FUNCTION

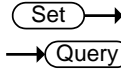

Description The FUNCTION command selects and outputs the selected output. The User parameter outputs an arbitrary waveform previously set by the SOURce[1|2]:FUNC:USER command.

Note If the function mode is changed and the current frequency setting is not supported by the new mode, the frequency setting will be altered to next highest value.

Vpp and Vrms or dBm amplitude values may have different maximum values due to differences such as crest factor. For example, if a 5Vrms square wave is changed to a sinewave, then the Vrms is automatically adjusted to 3.536.

The modulation, burst and sweep modes can only be used with some of the basic waveforms. If a mode is not supported, the conflicting mode will be disabled. See the table below.

	Sine	Square	Ramp	Pulse	Noise	ARB
AM	✓	✓	✓	✓	×	✓
FM	✓	✓	✓	×	×	×
PM	✓	✓	✓	×	×	×
FSK	✓	✓	✓	✓	×	×
SUM	✓	✓	✓	✓	✓	×
SWEEP	✓	✓	✓	×	×	×
BURST	✓	✓	✓	×	×	×

Syntax **SOURce[1|2]:FUNCTION {SINusoid|SQUare|RAMP|PULSe|NOISe| USER}**

Example **SOUR1:FUNC SIN**
Sets the output as a sine function.

Query Syntax **SOURce[1|2]:FUNCTION?**

Return Parameter SIN, SQU, RAMP, PULS, NOIS, USER Returns the current output type.

Example **SOUR1:FUNC?**
SIN
Current output is sine.

8-7-2. SOURce[1|2]:FREQUENCY

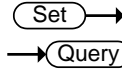

Description	The SOURce[1 2]:FREQUENCY command sets the output frequency for the selected channel. The query command returns the current frequency setting.										
Note	<p>The maximum and minimum frequency depends on the function mode.</p> <table border="1"> <tr> <td>Sine, Square</td> <td>1μHz~25MHz</td> </tr> <tr> <td>Ramp</td> <td>1μHz~1MHz</td> </tr> <tr> <td>Pulse</td> <td>500μHz~25MHz</td> </tr> <tr> <td>Noise</td> <td>Not applicable</td> </tr> <tr> <td>User</td> <td>1μHz~60MHz</td> </tr> </table> <p>If the function mode is changed and the current frequency setting is not supported by the new mode, the frequency setting will be altered to next highest value.</p> <p>The duty cycle of square waveforms depends on the frequency settings.</p> <p>1.0% to 99.0% ($frequency \leq 100 \text{ KHz}$)</p> <p>10% to 90% ($100 \text{ KHz} \leq frequency \leq 1 \text{ MHz}$)</p> <p>50% ($frequency \leq 25 \text{ MHz}$)</p> <p>If the frequency is changed and the set duty cycle cannot support the new frequency, the highest duty cycle available at that frequency will be used. A "settings conflict" error will result from the above scenario.</p>	Sine, Square	1μHz~25MHz	Ramp	1μHz~1MHz	Pulse	500μHz~25MHz	Noise	Not applicable	User	1μHz~60MHz
Sine, Square	1μHz~25MHz										
Ramp	1μHz~1MHz										
Pulse	500μHz~25MHz										
Noise	Not applicable										
User	1μHz~60MHz										
Syntax	SOURce[1 2]:FREQUENCY {<frequency> MINimum MAXimum}										
Example	SOUR1:FREQ MAX Sets the frequency to the maximum for the current mode.										
Query Syntax	SOURce[1 2]:FREQUENCY?										
Return Parameter	<NR3> Returns the frequency for the current mode.										
Example	SOUR1:FREQ? MAX +1.000000000000E+06 The maximum frequency that can be set for the current function is 1MHz.										

8-7-3. SOURce[1|2]:AMPLitude

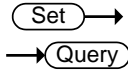

Description	The SOURce[1 2]:AMPLitude command sets the output amplitude for the selected channel. The query command returns the current amplitude settings.	
Note	<p>The maximum and minimum amplitude depends on the output termination. The default amplitude for all functions is 100 mVpp (50Ω). If the amplitude has been set and the output termination is changed from 50Ω to high impedance, the amplitude will double. Changing the output termination from high impedance to 50Ω will half the amplitude.</p> <p>The offset and amplitude are related by the following equation. $V_{offset} < V_{max} - V_{pp}/2$</p> <p>If the output termination is set to high impedance, dBm units cannot be used. The units will default to Vpp. The output amplitude can be affected by the function and unit chosen. Vpp and Vrms or dBm values may have different maximum values due to differences such as crest factor. For example, a 5Vrms square wave must be adjusted to 3.536 Vrms for a sine wave. The amplitude units can be explicitly used each time the SOURce[1 2]:AMPLitude command is used. Alternatively, the VOLT:UNIT command can be used to set the amplitude units for all commands.</p>	
Syntax	SOURce[1 2]:AMPLitude {< amplitude> MINimum MAXimum}	
Example	SOUR1:AMP MAX Sets the amplitude to the maximum for the current mode.	
Query Syntax	SOURce[1 2]:AMPLitude? {MINimum MAXimum}	
Return Parameter	<NR3>	Returns the amplitude for the current mode.
Example	SOUR1:AMP? MAX +5.0000E+00 The maximum amplitude that can be set for the current function is 5 volts.	

8-7-4. SOURce[1|2]:DCOffset

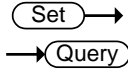

Description	Sets or queries the DC offset for the current mode.	
Note	<p>The offset parameter can be set to MINimum, MAXimum or DEFault. The default offset is 0 volts. The offset is limited by the output amplitude as shown below.</p> $ V_{offset} < V_{max} - V_{pp}/2$ <p>If the output specified is out of range, the maximum offset will be set.</p> <p>The offset is also determined by the output termination (50Ω or high impedance). If the offset has been set and the output termination has changed from 50Ω to high impedance, the offset will double. Changing the output termination from high impedance to 50Ω will half the offset.</p>	
Syntax	SOURce[1 2]:DCOffset {< offset> MINimum MAXimum}	
Example	SOUR1:DCO MAX Sets the offset to the maximum for the current mode.	
Query Syntax	SOURce[1 2]:DCOffset? {MINimum MAXimum}	
Return Parameter	<NR3>	Returns the offset for the current mode.
Example	SOUR1:DCO? +3.0000E+00 The offset for the current mode is set to +3 volts.	

8-7-5. SOURce[1|2]:SQUare:DCYCLE

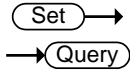

Description	Sets or queries the duty cycle for square waves only. The setting is remembered if the function mode is changed. The default duty cycle is 50%.	
Note	<p>The duty cycle of square waveforms depend on the frequency settings.</p> <p>1.0% to 99.0% ($frequency \leq 100$ KHz)</p> <p>10% to 90% ($100 \text{ KHz} \leq frequency \leq 1$ MHz)</p> <p>50% ($frequency \leq 25$ MHz)</p> <p>If the frequency is changed and the set duty cycle cannot support the new frequency, the highest duty cycle available at that frequency will be used. A “settings conflict” error will result from the above scenario.</p> <p>For square waveforms, the Apply command and AM/FM modulation modes ignore the duty cycle settings.</p>	
Syntax	SOURce[1 2]:SQUare:DCYCLE {< percent> MINimum MAXimum}	
Example	SOUR1:SQU:DCYC MAX Sets the duty cycle to the highest possible for the current frequency.	
Query Syntax	SOURce[1 2]:SQUare:DCYCLE? {MINimum MAXimum}	
Return Parameter	<NR3>	Returns the duty cycle as a percentage.
Example	SOUR1:SQU:DCYC? +5.00E+01 The duty cycle is set 50%.	

8-7-6. SOURce[1|2]:RAMP:SYMMetry

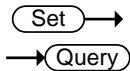

Description	Sets or queries the symmetry for ramp waves only. The setting is remembered if the function mode is changed. The default symmetry is 50%.	
-------------	---	--

Note	For ramp waveforms, the Apply command and AM/FM modulation modes ignore the current symmetry settings.	
Syntax	SOURce[1 2]:RAMP:SYMMetry {< percent> MINimum MAXimum}	
Example	SOUR1:RAMP:SYMM MAX Sets the symmetry to the 100%.	
Query Syntax	SOURce[1 2]:RAMP:SYMMetry? {MINimum MAXimum}	
Return Parameter	<NR3>	Returns the symmetry as a percentage.
Example	SOUR1:RAMP:SYMMetry? +1.0000E+02 The symmetry is set as 100%.	

8-7-7. OUTPut[1|2]

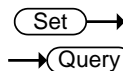

Description	Enables/Disables or queries the front panel output from the selected channel. The default is set to off.	
Note	If the output is overloaded by an external voltage, the output will turn off and an error message will be displayed. The overload must first be removed before the output can be turned on again with output command. Using the Apply command automatically sets the front panel output to on.	
Syntax	OUTPut[1 2] {OFF ON}	
Example	OUTP1 ON Turns the channel 1 output on.	
Query Syntax	OUTPut[1 2]?	
Return Parameter	1	ON
	0	OFF
Example	OUTP1? 1 The channel 1 output is currently on.	

8-7-8. OUTPut[1|2]:LOAD

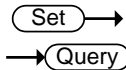

Description	Sets or queries the output termination. Two impedance settings can be chosen, DEFault (50Ω) and INFinity (high impedance >10 kΩ). The output termination is to be used as a reference only. If the output termination is set 50Ω but the actual load impedance is not 50Ω, then the amplitude and offset will not be correct.	
Note	If the amplitude has been set and the output termination is changed from 50Ω to high impedance, the amplitude will double. Changing the output termination from high impedance to 50Ω will half the amplitude. If the output termination is set to high impedance, dBm units cannot be used. The units will default to Vpp.	
Syntax	OUTPut[1 2]:LOAD {DEFault INFinity}	
Example	OUTP1:LOAD DEF Sets the channel 1 output termination to 50Ω.	
Query Syntax	OUTPut[1 2]:LOAD?	
Return Parameter	DEF	Default
	INF	INFinity
Example	OUTP1:LOAD? DEF The output termination for channel 1 is set to 50Ω.	

8-7-9. SOURce[1|2]:VOLTage:UNIT

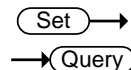

Description	Sets or queries the output amplitude units. There are three types of units: VPP, VRMS and DBM.	
Note	The units set with the VOLTage:UNIT command will be used as the default unit for all amplitude units unless a different unit is specifically used for a command. If the output termination is set to high impedance, dBm units cannot be used. The Units will automatically default to Vpp.	

Syntax	SOURce[1 2]:VOLTage:UNIT {VPP VRMS DBM}	
Example	SOUR1:VOLT:UNIT VPP Sets the amplitude units to Vpp.	
Query Syntax	SOURce[1 2]:VOLTage:UNIT?	
Return Parameter	VPP	Vpp
	VRMS	Vrms
	DBM	dBm
Example	SOUR1:VOLT:UNIT? VPP The amplitude units are set to Vpp.	

8-8. Pulse Configuration Commands

The pulse chapter is used to control and output pulse waveforms. Unlike the APPLy command, low level control is possible including setting the rise time, fall time, period and pulse width.

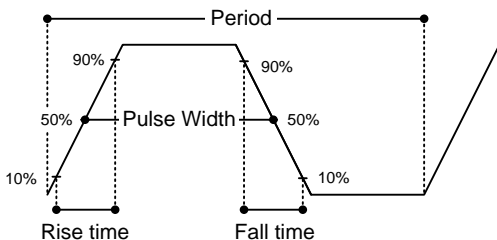

8-8-1. SOURce[1|2]:PULSe:PERiod

Set →

→ Query

Description Sets or queries the pulse period. The default period is 1 ms.

Note The pulse period must be greater than the pulse width and edge time(1.6x) combined.

$\text{Pulse Width} + (1.6 * \text{Edge Time}) < \text{Period}$

If the edge time or pulse width are too great, they will automatically be reduced to fit the period by the function generator.

The PULSe:PERiod function will change the period for all

	functions, not just for the pulse waveforms. If a different function is chosen and the current period is out of range, the period will be automatically adjusted to suit the new function.
Syntax	SOURce[1 2]:PULSe:PERiod {<seconds> MINimum MAXimum}
Example	SOUR1:PULS:PER MIN Sets the period to the minimum time allowed.
Query Syntax	SOURce[1 2]:PULSe:PERiod? [MINimum MAXimum]
Return Parameter	<seconds> 40ns~2000s
Example	SOUR1:PULS:PER? +1.0000E+01 The period is set to 10 seconds.

8-8-2. SOURce[1|2]:PULSe:WIDTh

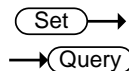

Description	Sets or queries the pulse width. The default pulse width is 100us. The minimum pulse width is affected by the period time. If the period is over 20 or 200 seconds, then the minimum pulse width is 1us and 10us, respectively. Pulse width is defined as the time from the rising to falling edges (at a threshold of 50%).
Note	The pulse width cannot be less than the edge time times 1.6. Pulse Width > 1.6 * Edge Time The pulse width must be less than the period minus the edge time (x1.6). Pulse Width < Period – (1.6 *Edge Time)
Syntax	SOURce[1 2]:PULSe:WIDTh {<seconds> MINimum MAXimum}
Example	SOUR1:PULS:WIDT MAX Sets the pulse width to the maximum allowed.
Query Syntax	SOURce[1 2]:PULSe:WIDTh? [MINimum MAXimum]
Return Parameter	<seconds> 20 ns ~ 1999.9 seconds

Example

SOUR1:PULS:WIDT? MIN

+8.0000E-09

The pulse width is set to 8 nanoseconds.

8-9. Amplitude Modulation (AM) Commands

8-9-1. AM Overview

To successfully create an AM waveform, the following commands must be executed in order.

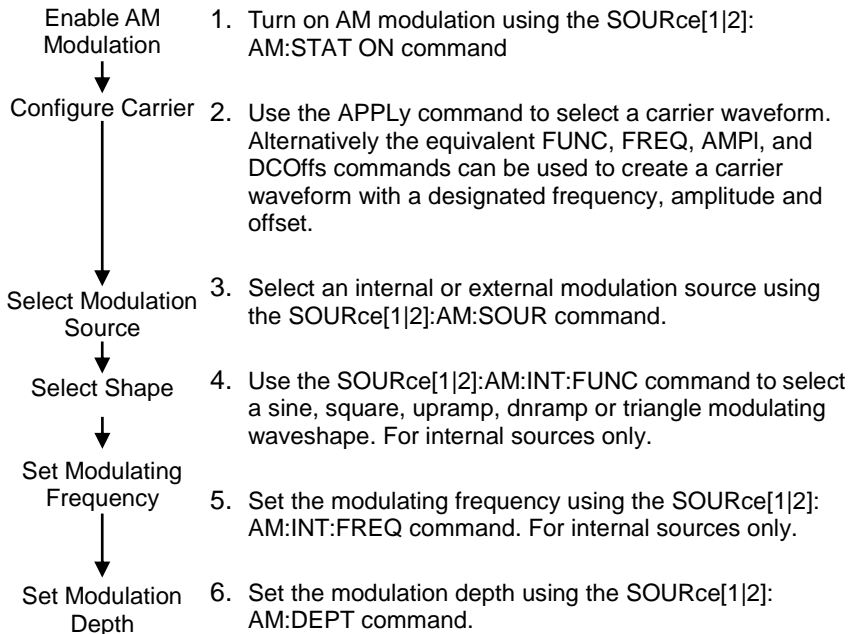

8-9-2. SOURce[1|2]:AM:STATe

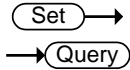

Description	Sets or disables AM modulation. By default AM modulation is disabled. AM modulation must be enabled before setting other parameters.
Note	Burst or sweep mode will be disabled if AM modulation is enabled. As only one modulation is allowed at any one time, other modulation modes will be disabled when AM modulation is enabled.
Syntax	SOURce[1 2]:AM:STATe {OFF ON}
Example	SOUR1:AM:STAT ON Enables AM modulation.
Query Syntax	SOURce[1 2]:AM:STATe?
Return Parameter	0 Disabled (OFF)
	1 Enabled (ON)
Example	SOUR1:AM:STAT? 1 AM modulation mode is currently enabled.

8-9-3. SOURce[1|2]:AM:SOURce

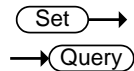

Description	Sets or queries the modulation source as internal or external. Internal is the default modulation source.
Note	If an external modulation source is selected, modulation depth is limited to $\pm 5V$ from the MOD INPUT terminal on the rear panel. For example, if modulation depth is set to 100%, then the maximum amplitude is +5V, and the minimum amplitude is -5V.
Syntax	SOURce[1 2]:AM:SOURce {INTernal EXTernal}
Example	SOUR1:AM:SOUR EXT Sets the modulation source to external.
Query Syntax	SOURce[1 2]:AM:SOURce?
Return Parameter	INT Internal
	EXT External

Example **SOUR1:AM:SOUR?**
INT
The modulation source is set to internal.

8-9-4. SOURce[1|2]:AM:INTernal:FUNction

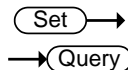

Description Sets the shape of the modulating waveform from sine, square, triangle, upramp and dn ramp. The default shape is sine.

Note Square and triangle waveforms have a 50% duty cycle. Upramp and dn ramp have a symmetry of 100% and 0%, respectively.

Syntax **SOURce[1|2]:AM:INTernal:FUNction**
{SINusoid|SQUare|TRIangle|UPRamp|DNRamp}

Example **SOUR1:AM:INT:FUNC SIN**
Sets the AM modulating wave shape to sine.

Query Syntax **SOURce[1|2]:AM:INTernal:FUNction?**

Return Parameter	SIN	Sine	UPRAMP	Upramp
	SQU	Square	DNRAMP	Dn ramp
	TRI	Triangle		

Example **SOUR1:AM:INT:FUNC?**
SIN
The shape for the modulating waveform is Sine.

8-9-5. SOURce[1|2]:AM:INTernal:FREQuency

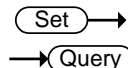

Description Sets the frequency of the internal modulating waveform only. The default frequency is 100Hz.

Syntax **SOURce[1|2]:AM:INTernal:FREQuency**
{<frequency>|MINimum|MAXimum}

Parameter <frequency> 2 mHz~ 20 kHz

Example **SOUR1:AM:INT:FREQ +1.0000E+02**
Sets the modulating frequency to 100Hz.

Query Syntax	SOURce[1 2]:AM:INTernal:FREQuency? [MINimum MAXimum]
Return Parameter	<NR3> Returns the frequency in Hz.
Example	SOUR1:AM:INT:FREQ? MIN +1.0000E+02 Returns the minimum frequency allowed.

8-9-6. SOURce[1|2]:AM:DEPT_h

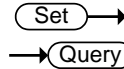

Description	Sets or queries the modulation depth for internal sources only. The default is 100%.
Note	The function generator will not output more than $\pm 5V$, regardless of the modulation depth. The modulation depth of an external source is controlled using the $\pm 5V$ MOD INPUT terminal on the rear panel, and not the SOURce[1 2]:AM:DEPTH command.
Syntax	SOURce[1 2]:AM:DEPT_h {<depth in percent> [MINimum MAXimum]
Parameter	<depth in percent> 0~120%
Example	SOUR1:AM:DEPT 50 Sets the modulation depth to 50%.
Query Syntax	SOURce[1 2]:AM:DEPT_h? [MINimum MAXimum]
Return Parameter	<NR3> Return the modulation depth as a percentage.
Example	SOUR1:AM:DEPT? +1.0000E+02 The modulation depth is 100%.

8-10. Frequency Modulation (FM) Commands

8-10-1. FM Overview

The following is an overview of the steps required to generate an FM waveform.

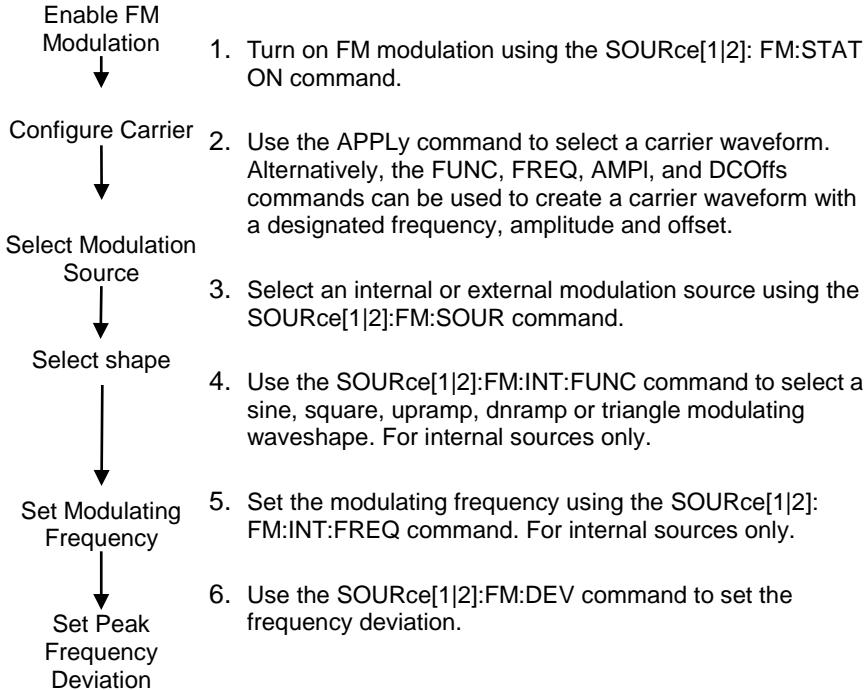

8-10-2. SOURce[1|2]:FM:STATe

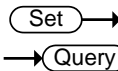

Description	Sets or disables FM modulation. By default FM modulation is disabled. FM modulation must be enabled before setting other parameters.
Note	Burst or sweep mode will be disabled if FM modulation is enabled. As only one modulation is allowed at any one time, other modulation modes will be disabled when FM modulation is enabled.
Syntax	SOUR[1 2]:FM:STATe {OFF ON}
Example	SOUR1:FM:STAT ON Enables FM modulation.

Query Syntax	SOURce[1 2]:FM:STATe?	
Return Parameter	0	Disabled (OFF)
	1	Enabled (ON)
Example	SOUR1:FM:STAT? 1 FM modulation mode is currently enabled.	

8-10-3. SOURce[1|2]:FM:SOURce

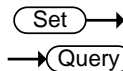

Description	Sets or queries the modulation source as internal or external. Internal is the default modulation source.	
Note	If an external modulation source is selected, modulation depth is limited to $\pm 5V$ from the MOD INPUT terminal on the rear panel. For example, if modulation depth is set to 100%, then the maximum amplitude is +5V, and the minimum amplitude is -5V.	
Syntax	SOURce[1 2]:FM:SOURce {INTernal EXTernal}	
Example	SOUR1:FM:SOUR EXT Sets the modulation source to external.	
Query Syntax	SOURce[1 2]:FM:SOURce?	
Return Parameter	INT	Internal
	EXT	External
Example	SOUR1:FM:SOUR? INT The modulation source is set to internal.	

8-10-4. SOURce[1|2]:FM:INTernal:FUNCTion

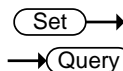

Description	Sets the shape of the modulating waveform from sine, square, triangle, upramp and dn ramp. The default shape is sine.	
-------------	---	--

Note Square and triangle waveforms have a 50% duty cycle. Upramp and dn ramp have a symmetry of 100% and 0%, respectively.

Syntax **SOURce[1|2]:FM:INTernal:FUNCTION**
{SINusoid|SQUare|TRIangle|UPRamp|DNRamp}

Example **SOUR1:FM:INT:FUNC SIN**
 Sets the FM modulating wave shape to sine.

Query Syntax **SOURce[1|2]:FM:INTernal:FUNCTION?**

Return Parameter	SIN	Sine	UPRAMP	Upramp
	SQU	Square	DNRAMP	Dn ramp
	TRI	Triangle		

Example **SOUR1:FM:INT:FUNC?**
SIN
 The shape for the modulating waveform is Sine.

8-10-5. SOURce[1|2]:FM:INTernal:FREQuency

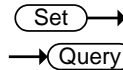

Description Sets the frequency of the internal modulating waveform only. The default frequency is 10Hz.

Syntax **SOURce[1|2]:FM:INTernal:FREQuency**
{<frequency>|MINimum|MAXimum}

Parameter <frequency> 2 mHz~ 20 kHz

Example **SOUR1:FM:INT:FREQ 100**
 Sets the modulating frequency to 100Hz.

Query Syntax **SOURce[1|2]:FM:INTernal:FREQuency?**
[MINimum|MAXimum]

Return Parameter <NR3> Returns the frequency in Hz.

Example **SOUR1:FM:INT:FREQ? MAX**
+2.0000E+04
 Returns the maximum frequency allowed.

8-10-6. SOURce[1|2]:FM:DEVIation

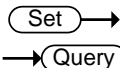

Description	<p>Sets or queries the peak frequency deviation of the modulating waveform from the carrier waveform. The default peak deviation is 100Hz.</p> <p>The frequency deviation of external sources is controlled using the $\pm 5V$ MOD INPUT terminal on the rear panel. A positive signal ($>0 \sim +5V$) will increase the deviation (up to the set frequency deviation), whilst a negative voltage will reduce the deviation.</p>	
Note	<p>The relationship of peak deviation to modulating frequency and carrier frequency is shown below.</p> <p>Peak deviation = modulating frequency – carrier frequency.</p> <p>The carrier frequency must be greater than or equal to the peak deviation frequency. The sum of the deviation and carrier frequency must not exceed the maximum frequency for a specific carrier shape. If an out of range deviation is set for any of the above conditions, the deviation will be automatically adjusted to the maximum value allowed and an “out of range” error will be generated.</p> <p>For square wave carrier waveforms, the deviation may cause the duty cycle frequency boundary to be exceeded. In these conditions the duty cycle will be adjusted to the maximum allowed and a “settings conflict” error will be generated.</p>	
Syntax	SOURce[1 2]:FM:DEVIation {<peak deviation in Hz> MINimum MAXimum}	
Parameter	<peak deviation in Hz>	DC~25MHz DC~15MHz(square) DC~1MHz (Ramp)
Example	SOUR1:FM:DEV MAX Sets the frequency deviation to the maximum value allowed.	
Query Syntax	SOURce[1 2]:FM:DEVIation? [MINimum MAXimum]	
Return Parameter	<NR3>	Returns the frequency deviation in Hz.
Example	SOURce[1 2]:FM:DEVIation? MAX +1.0000E+01 Returns the maximum frequency deviation allowed.	

8-11. Frequency-Shift Keying (FSK) Commands

8-11-1. FSK Overview

The following is an overview of the steps required to generate an FSK modulated waveform.

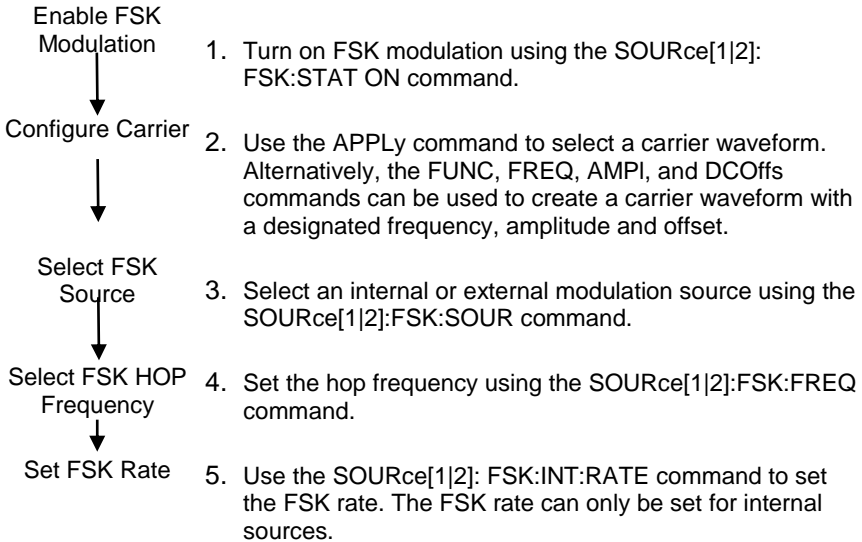

8-11-2. SOURce[1|2]:FSKey:STATe

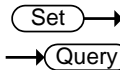

Description	Turns FSK Modulation on or off. By default FSK modulation is off.	
Note	Burst or sweep mode will be disabled if FSK modulation is enabled. As only one modulation is allowed at any one time, other modulation modes will be disabled when FSK modulation is enabled.	
Syntax	SOURce[1 2]:FSKey:STATe {OFF ON}	
Example	SOUR1:FSK:STAT ON Enables FSK modulation	
Query Syntax	SOURce[1 2]:FSKey:STATe?	
Return Parameter	0	Disabled (OFF)
	1	Enabled (ON)

Example **SOUR1:FSK:STAT?**
1
 FSK modulation is currently enabled.

8-11-3. SOURce[1|2]:FSKey:SOURce

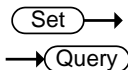

Description Sets or queries the FSK source as internal or external.
 Internal is the default source.

Note If an external FSK source is selected, FSK rate is controlled
 by the Trigger INPUT terminal on the rear panel.

Syntax **SOURce[1|2]:FSKey:SOURce {INTernal|EXTernal}**

Example **SOUR1:FSK:SOUR EXT**
 Sets the FSK source to external.

Query Syntax **SOURce[1|2]:FSKey:SOURce?**

Return Parameter	INT	Internal
	EXT	External

Example **SOUR1:FSK:SOUR?**
INT
 The FSK source is set to internal.

8-11-4. SOURce[1|2]:FSKey:FREQuency

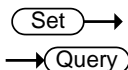

Description Sets the FSK hop frequency. The default hop frequency is set
 to 100Hz.

Note For FSK, the modulating waveform is a square wave with a
 duty cycle of 50%.

Syntax **SOURce[1|2]:FSKey:FREQuency**
{<frequency>|MINimum|MAXimum}

Parameter	<frequency>	1 μHz~25MHz(sine)
		1 μHz~15MHz(Square、Pulse)
		1 μHz~1MHz(Ramp)

Example	SOUR1:FSK:FREQ +1.0000E+02 Sets the FSK hop frequency to to 100Hz.
Query Syntax	SOURce[1 2]:FSKey:FREQUENCY? [MINimum MAXimum]
Return Parameter	<NR3> Returns the frequency in Hz.
Example	SOUR1:FSK:FREQ? MAX +2.5000E+06 Returns the maximum hop frequency allowed.

8-11-5. SOURce[1|2]:FSKey:INTernal:RATE

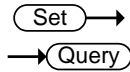

Description	Sets or queries the FSK rate for internal sources only.
Note	External sources will ignore this command.
Syntax	SOURce[1 2]:FSKey:INTernal:RATE {<rate in Hz> MINimum MAXimum}
Parameter	<rate in Hz> 2 mHz~100 kHz
Example	SOUR1:FSK:INT:RATE MAX Sets the rate to the maximum (100kHz).
Query Syntax	SOURce[1 2]:FSKey:INTernal:RATE? [MINimum MAXimum]
Return Parameter	<NR3> Returns the FSK rate in Hz.
Example	SOUR1:FSK:INT:RATE? MAX +1.0000E+05 Returns the maximum FSK rate allowed.

8-12. Phase Modulation (PM) Commands

8-12-1. PM Overview

The following is an overview of the steps required to generate a PM modulated waveform.

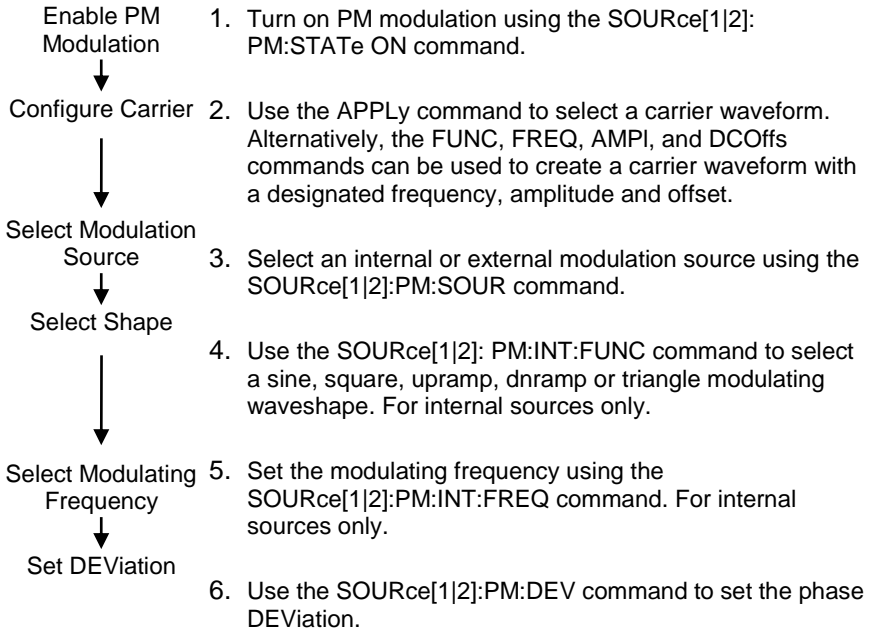

8-12-2. `SOURce[1|2]:PM:STATe`

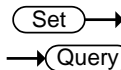

Description Turns PM Modulation on or off. By default PM modulation is off.

Note Burst or sweep mode will be disabled if PM modulation is enabled. As only one modulation is allowed at any one time, other modulation modes will be disabled when PM modulation is enabled.

Syntax **`SOURce[1|2]:PM:STATe {OFF|ON}`**

Example **`SOUR1:PM:STAT ON`**
Enables PM modulation

Query Syntax	SOURce[1 2]:PM:STATe?	
Return Parameter	0	Disabled (OFF)
	1	Enabled (ON)
Example	SOUR1:PM:STAT? 1 PM modulation is currently enabled.	

8-12-3. SOURce[1|2]:PM:SOURce

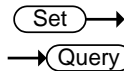

Description	Sets or queries the PM source as internal or external. Internal is the default source.	
Note	If an external PM source is selected, the phase modulation is controlled by the MOD INPUT terminal on the rear panel.	
Syntax	SOURce[1 2]:PM:SOURce {INTERNAL EXTERNAL}	
Example	SOUR1:PM:SOUR EXT Sets the PM source to external.	
Query Syntax	SOURce[1 2]:PM:SOURce?	
Return Parameter	INT	Internal
	EXT	External
Example	SOUR1:PM:SOUR? INT The PM source is set to internal.	

8-12-4. SOURce[1|2]:PM:INTERNAL:FUNction

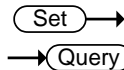

Description	Sets the shape of the modulating waveform from sine, square, triangle, upramp and dn ramp. The default shape is sine.	
Note	Square and triangle waveforms have a 50% duty cycle. Upramp and dn ramp have a symmetry to 100% and 0%, respectively. .	
Syntax	SOURce[1 2]:PM:INTERNAL:FUNction {SINusoid SQUare TRIangle UPRamp DNRamp}	

Example	SOUR1:PM:INT:FUN SIN			
	Sets the PM modulating wave shape to sine. .			
Query Syntax	SOURce[1 2]:PM:INTernal:FUNction?			
Return Parameter	SIN	Sine	UPRAMP	Upramp
	SQU	Square	DNRAMP	Dnramp
	TRI	Triangle		

Example	SOUR1:PM:INT:FUNC?			
	SIN			
	The shape for the modulating waveform is Sine.			

8-12-5. SOURce[1|2]:PM:INTernal:FREQuency

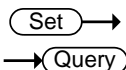

Description	Sets the modulating waveform frequency for internal sources. The default frequency is set to 100Hz.		
Syntax	SOURce[1 2]:PM:INTernal:FREQuency {<frequency> MINimum MAXimum}		
Parameter	<frequency>	2 mHz~ 20 kHz	
Example	SOUR1:PM:INT:FREQ MAX		
	Sets the frequency to the maximum value.		
Query Syntax	SOURce[1 2]:PM:INTernal:FREQuency?		
Return Parameter	<NR3>	Returns the frequency in Hz.	
Example	SOUR1:PM:INT:FREQ? MAX		
	+2.0000E+04		
	Returns the modulating frequency. (20kHz)		

8-12-6. SOURce[1|2]:PM:DEVIation

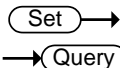

Description	Sets or queries the phase deviation of the modulating waveform from the carrier waveform. The default phase deviation is 180°.
Note	For external sources, the phase deviation is controlled by the ±5V MOD Input terminal on the rear panel. If the phase deviation is set to 180 degrees, then +5V represents a deviation of 180 degrees. A lower input voltage will decrease the set phase deviation.
Syntax	SOURce[1 2]:PM:DEVIation {< phase> minimum maximum}
Parameter	<percent> 0°~360°
Example	SOUR1:PM:DEVIation +3.0000E+01 Sets the deviation to 30°.
Query Syntax	SOURce[1 2]:PM:DEVIation?
Return Parameter	<NR3> Returns the deviation .
Example	SOUR1:PM:DEVIation? +3.0000E+01 The current deviation is 30°.

8-13. SUM Modulation (SUM) Commands

8-13-1. SUM Overview

The following is an overview of the steps required to generate a SUM modulated waveform.

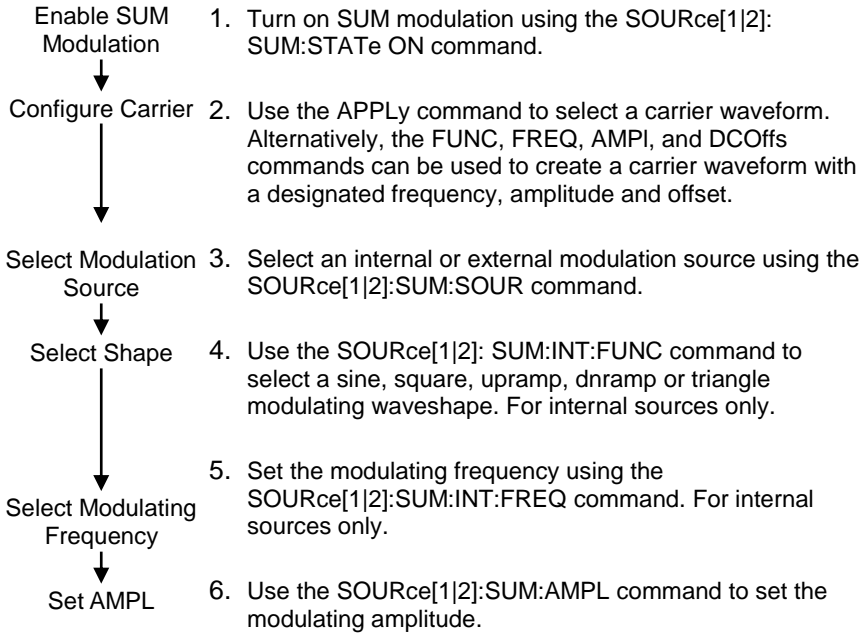

8-13-2. `SOURce[1|2]:SUM:STATe`

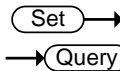

Description Turns SUM Modulation on or off. By default SUM modulation is off.

Note Burst or sweep mode will be disabled if SUM modulation is enabled. As only one modulation is allowed at any one time, other modulation modes will be disabled when SUM modulation is enabled.

Syntax `SOURce[1|2]:SUM:STATe {OFF|ON}`

Example `SOUR1:SUM:STAT ON`
Enables SUM modulation

Query Syntax	SOURce[1 2]:SUM:STATe?	
Return Parameter	0	Disabled (OFF)
	1	Enabled (ON)
Example	SOUR1:SUM:STAT? ON SUM modulation is currently enabled.	

8-13-3. SOURce[1|2]:SUM:SOURce

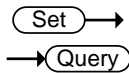

Description	Sets or queries the SUM source as internal or external. Internal is the default source.	
Note	If an external SUM source is selected, the amplitude is controlled by the MOD INPUT terminal on the rear panel.	
Syntax	SOURce[1 2]:SUM:SOURce {INTERNAL EXTERNAL}	
Example	SOUR1:SUM:SOUR EXT Sets the SUM source to external.	
Query Syntax	SOURce[1 2]:SUM:SOURce?	
Return Parameter	INT	Internal
	EXT	External
Example	SOUR1:SUM:SOUR? INT The SUM source is set to internal.	

8-13-4. SOURce[1|2]:SUM:INTERNAL:FUNCTION

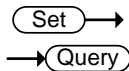

Description	Sets the shape of the modulating waveform from sine, square, triangle, upramp and dn ramp. The default shape is sine.	
Note	Square and triangle waveforms have a 50% duty cycle. Upramp and dn ramp have a symmetry to 100% and 0%, respectively. .	

Syntax	SOURce[1 2]:SUM:INTernal:FUNction {SINusoid SQUare TRIangle UPRamp DNRamp}			
Example	SOUR1:SUM:INT:FUN SIN Sets the SUM modulating wave shape to sine.			
Query Syntax	SOURce[1 2]:SUM:INTernal:FUNction?			
Return Parameter	SIN	Sine	UPRAMP	Upramp
	SQU	Square	DNRAMP	Dnramp
	TRI	Triangle		
Example	SOUR1:SUM:INT:FUNC? SIN The shape for the modulating waveform is Sine.			

8-13-5.SOURce[1|2]:SUM:INTernal:FREQUency

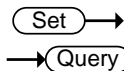

Description	Sets the modulating waveform frequency for internal sources. The default frequency is set to 100Hz.			
Syntax	SOURce[1 2]:SUM:INTernal:FREQUency {<frequency> MINimum MAXimum}			
Parameter	<frequency>	2 mHz~ 20 kHz		
Example	SOUR1:SUM:INT:FREQ MAX Sets the frequency to the maximum value.			
Query Syntax	SOURce[1 2]:SUM:INTernal:FREQUency?			
Return Parameter	<NR3>	Returns the frequency in Hz.		
Example	SOUR1:SUM:INT:FREQ? MAX +2.0000E+04 Returns the modulating frequency (20kHz).			

8-13-6. SOURce[1|2]:SUM:AMPL

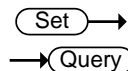

Description	Sets or queries the amplitude of the modulating waveform from the carrier waveform. The default phase amplitude is 50%.			
-------------	---	--	--	--

Note	If an external SUM source is selected, the amplitude of the modulated waveform is controlled using the $\pm 5V$ MOD INPUT terminal on the rear panel. A positive signal ($>0\sim+5V$) will increase the AMPLitude (up to the set amplitude), whilst a negative voltage will reduce the amplitude.
Syntax	SOURce[1 2]:SUM:AMPL{< percent> minimum maximum}
Parameter	<percent> 0%~100% >
Example	SOUR1:SUM:AMPLitude +3.0000E+01 Sets the amplitude to 30%.
Query Syntax	SOURce[1 2]:SUM:AMPLitude?
Return Parameter	<NR3> Returns the amplitude .
Example	SOUR1:SUM:AMPLitude? +3.0000E+01 The current amplitude is 30%.

8-14. Frequency Sweep Commands

8-14-1. Sweep Overview

Below shows the order in which commands must be executed to perform a sweep.

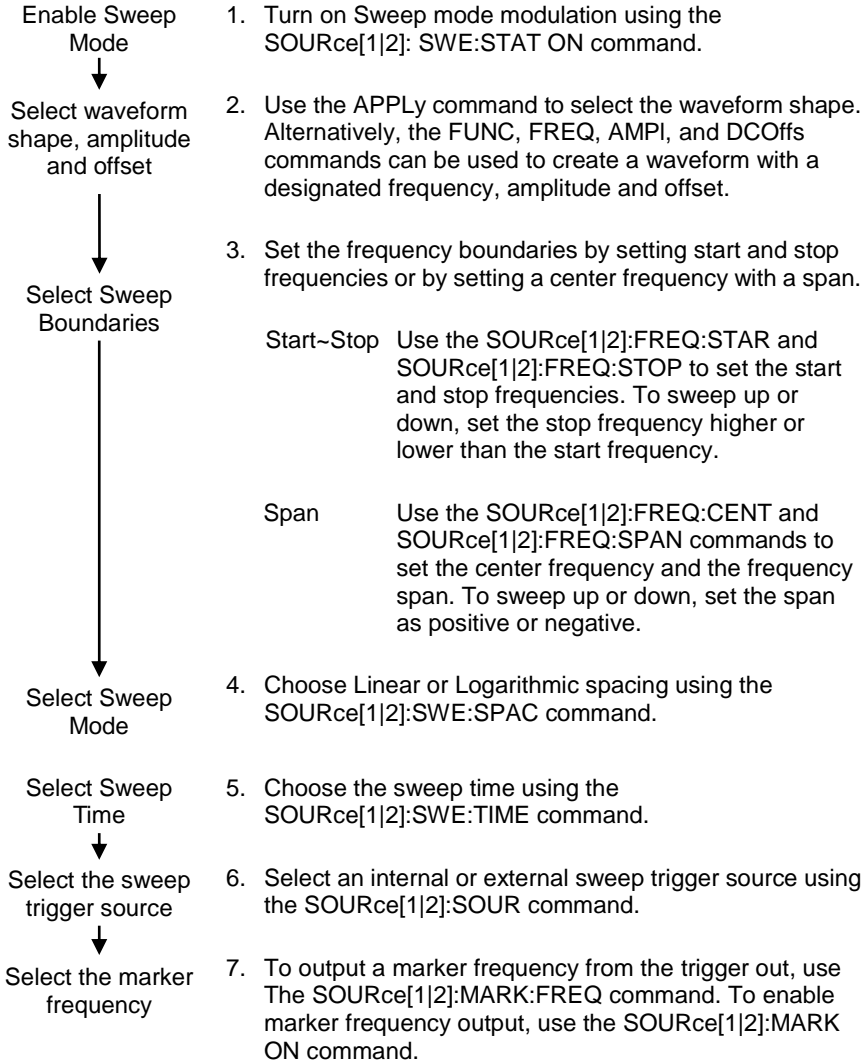

The marker frequency can be set to a value within the sweep span.

8-14-2. SOURce[1|2]:SWEep:STATe

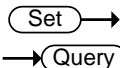

Description	Sets or disables Sweep mode. By default Sweep is disabled. Sweep modulation must be enabled before setting other parameters.	
Note	Any modulation modes or Burst mode will be disabled if sweep mode is enabled.	
Syntax	SOURce[1 2]:SWEep:STATe {OFF ON}	
Example	SOUR1:SWE:STAT ON Enables sweep mode.	
Query Syntax	SOURce[1 2]:SWEep:STATe?	
Return Parameter	0	Disabled (OFF)
	1	Enabled (ON)
Example	SOUR1:SWE:STAT? 1 Sweep mode is currently enabled.	

8-14-3. SOURce[1|2]:FREQuency:STARt

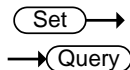

Description	Sets the start frequency of the sweep. 100Hz is the default start frequency.	
Note	To sweep up or down, set the stop frequency higher or lower than the start frequency.	
Syntax	SOURce[1 2]:FREQuency:STARt {<frequency> MINimum MAXimum}	
Parameter	<frequency>	1μHz~ 25MHz 1μHz~ 15MHz(Square) 1μHz~ 1MHz (Ramp)
Example	SOUR1:FREQ:STAR +2.000E+03 Sets the start frequency to 2kHz.	
Query Syntax	SOURce[1 2]:FREQuency:STARt? [MINimum MAXimum]	
Return Parameter	<NR3>	Returns the start frequency in Hz.

Example **SOUR1:FREQ:STAR? MAX**
+8.0000E+0
Returns the maximum start frequency allowed.

8-14-4. SOURce[1|2]:FREQuency:STOP

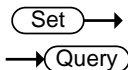

Description	Sets the stop frequency of the sweep. 1 kHz is the default start frequency.
Note	To sweep up or down, set the stop frequency higher or lower than the start frequency.
Syntax	SOURce[1 2]:FREQuency:STOP {<frequency> MINimum MAXimum}
Parameter	<frequency> 1μHz~ 25MHz 1μHz~ 15MHz(Square) 1μHz~ 1MHz (Ramp)
Example	SOUR1:FREQ:STOP +2.0000E+03 Sets the stop frequency to 2kHz.
Query Syntax	SOURce[1 2]:FREQuency:STOP? [MINimum MAXimum]
Return Parameter	<NR3> Returns the stop frequency in Hz.

Example **SOUR1:FREQ:STOP? MAX**
+8.0000E+00
Returns the maximum stop frequency allowed.

8-14-5. SOURce[1|2]:FREQuency:CENTer

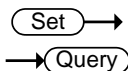

Description	Sets and queries the center frequency of the sweep. 550 Hz is the default center frequency.
Note	The maximum center frequency depends on the sweep span and maximum frequency: max center freq = max freq – span/2
Syntax	SOURce[1 2]:FREQuency:CENTer {<frequency> MINimum MAXimum}

Parameter	<frequency>	450Hz~ 25MHz 450Hz~ 15MHz(Square) 450Hz~ 1MHz (Ramp)
Example	SOUR1:FREQ:CENT +2.0000E+03	Sets the center frequency to 2kHz.
Query Syntax	SOURce[1 2]:FREQuency:CENTer? [MINimum] MAXimum]	
Return Parameter	<NR3>	Returns the stop frequency in Hz.
Example	SOUR1:FREQ:CENT? MAX +8.0000E+00	Returns the maximum center frequency allowed, depending on the span.

8-14-6. SOURce[1|2]:FREQuency:SPAN

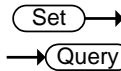

Description		Sets and queries the frequency span of the sweep. 900 Hz is the default frequency span. The span frequency is equal to the stop-start frequencies.
Note		To sweep up or down, set the span as positive or negative. The maximum span frequency has a relationship to the center frequency and maximum frequency: $\text{max freq span} = 2(\text{max freq} - \text{center freq})$
Syntax		SOURce[1 2]:FREQuency:SPAN {<frequency> MINimum MAXimum}
Parameter	<frequency>	1μHz~ 25MHz 1μHz~ 15MHz(Square) 1μHz~ 1MHz (Ramp)
Example	SOUR1:FREQ:SPAN +2.0000E+03	Sets the frequency span to 2kHz.
Query Syntax	SOURce[1 2]:FREQuency:SPAN? [MINimum] MAXimum]	
Return Parameter	<NR3>	Returns the frequency span in Hz.

Example **SOUR1:FREQ:SPAN?**
+2.0000E+03
Returns the frequency span for the current sweep.

8-14-7. SOURce[1|2]:SWEep:SPACing

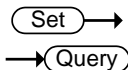

Description Sets linear or logarithmic sweep spacing. The default spacing is linear.

Syntax **SOURce[1|2]:SWEep:SPACing {LINear|LOGarithmic}**

Example **SOUR1:SWE:SPAC LIN**
Sets the spacing to linear.

Query Syntax **SOURce[1|2]:SWEep:SPACing?**

Return Parameter	LIN	Linear spacing
	LOG	Logarithmic spacing

Example **SOUR1:SWE:SPAC?**
LIN
The spacing is currently set as linear.

8-14-8. SOURce[1|2]:SWEep:TIME

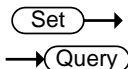

Description Sets or queries the sweep time. The default sweep time is 1 second.

Note The function generator automatically determines the number of frequency points that are used for the sweep based on the sweep time.

Syntax **SOURce[1|2]:SWEep:TIME**
{<seconds>|MINimum|MAXimum}

Parameter <seconds> 1 ms ~ 500 s

Example **SOUR1:SWE:TIME +1.0000E+00**
Sets the sweep time to 1 second.

Query Syntax	SOURce[1 2]:SWEep:TIME? {<seconds> MINimum MAXimum}
Return Parameter	<NR3> Returns sweep time in seconds.
Example	SOUR1:SWE:TIME? +2.0000E+01 Returns the sweep time (20 seconds).

8-14-9. SOURce[1|2]:SWEep:SOURce

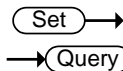

Description	Sets or queries the trigger source as immediate (internal), external or manual. Immediate (internal) is the default trigger source. IMMEDIATE will constantly output a swept waveform. EXTERNAL will output a swept waveform after each external trigger pulse. Manual will output a swept waveform after the trigger softkey is pressed.
Note	If the APPLY command was used to create the waveform shape, the source is automatically set to IMMEDIATE. The *OPC/*OPC? command/query can be used to signal the end of the sweep.
Syntax	SOURce[1 2]: SWEep:SOURce {IMMEDIATE EXTERNAL MANual}
Example	SOUR1: SWE:SOUR EXT Sets the sweep source to external.
Query Syntax	SOURce[1 2]: SWEep:SOURce?
Return Parameter	IMM Immediate EXT External MANual Manual
Example	SOUR1:SWE:SOUR? IMM The sweep source is set to immediate.

8-14-10. SOURce[1|2]:MARKer:FREQuency

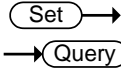

Description	Sets or queries the marker frequency. The default marker frequency is 550 Hz. The marker frequency is used to output a trigger out signal from the trigger terminal on the rear panel.
Note	The marker frequency must be between the start and stop frequencies. If the marker frequency is set to a value that is out of the range, the marker frequency will be set to the center frequency and a “settings conflict” error will be generated.
Syntax	SOURce[1 2]:MARKer:FREQuency {<frequency> MINimum MAXimum}
Parameter	<frequency> 1μHz ~ 25 MHz 1 μHz ~ 1 MHz (Ramp)
Example	SOUR1:MARK:FREQ +1.0000E+03 Sets the marker frequency to 1 kHz.
Query Syntax	SOURce[1 2]:MARKer:FREQuency? [MINimum MAXimum]
Return Parameter	<NR3> Returns the marker frequency in Hz.
Example	SOUR1:MARK:FREQ? MAX +1.0000E+03 Returns the marker frequency (1 kHz).

8-14-11. SOURce[1|2]:MARKer

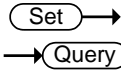

Description	Turns the marker frequency on or off. The default is off.
Note	<p>MARKer ON The SYNC signal goes logically high at the start of each sweep and goes low at the marker frequency.</p> <p>MARKer OFF The SYNC terminal outputs a square wave with a 50% duty cycle at the start of each sweep.</p>
Syntax	SOURce[1 2]:MARKer {OFF ON}
Example	SOUR1:MARK ON Enables the marker frequency.

Query Syntax	SOURce[1 2]:MARKer?	
Return Parameter	0	Disabled
	1	Enabled
Example	SOUR1:MARK? 1	
	The marker frequency is enabled.	

8-15. Burst Mode Commands

8-15-1. Burst Mode Overview

Burst mode can be configured to use an internal trigger (N Cycle mode) or an external trigger (Gate mode) using the Trigger INPUT terminal on the rear panel. Using N Cycle mode, each time the function generator receives a trigger, the function generator will output a specified number of waveform cycles (burst). After the burst, the function generator will wait for the next trigger before outputting another burst. N Cycle is the default Burst mode.

The alternative to using a specified number of cycles, Gate mode uses the external trigger to turn on or off the output. When the Trigger INPUT signal is high*, waveforms are continuously output (creating a burst). When the Trigger INPUT signal goes low*, the waveforms will stop being output after the last waveform completes its period. The voltage level of the output will remain equal to the starting phase of the burst waveforms, ready for the signal to go high* again.

*assuming the Trigger polarity is not inverted.

Only one burst mode can be used at any one time. The burst mode depends on the source of the trigger (internal, external, manual) and the source of the burst.

Burst Mode & Source	Function		
	N Cycle*	Cycle	Phase
Triggered – IMMEDIATE, BUS	Available	Available	Available
Triggered - EXTERNAL, MANUAL	Available	Unused	Available
Gated pulse - IMMEDIATE	Unused	Unused	Available

*burst count

The following is an overview of the steps required to generate a burst waveform.

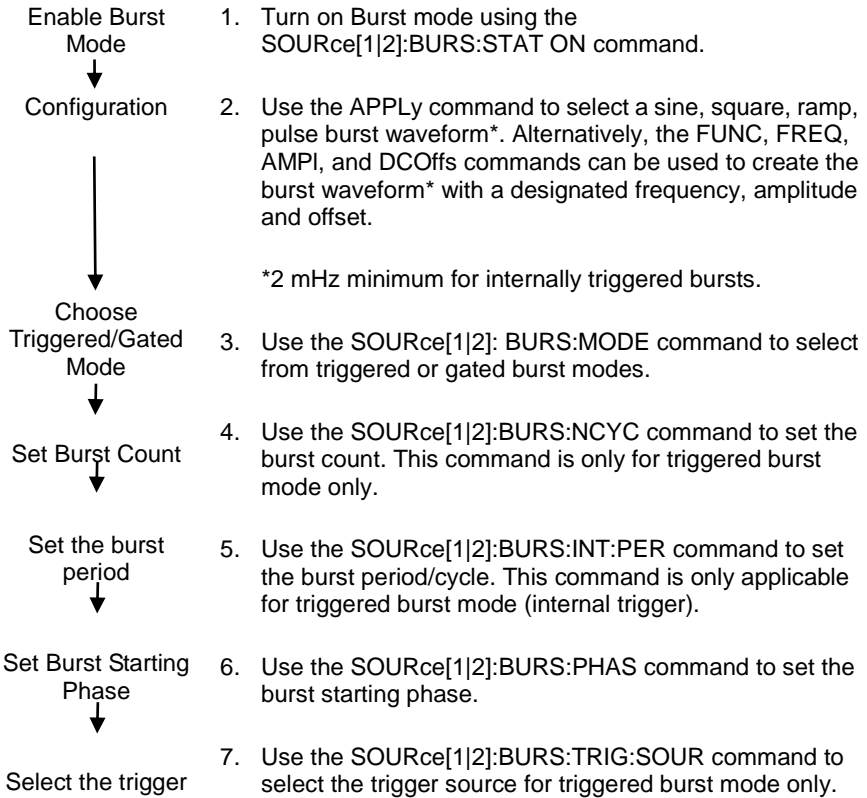

*2 mHz minimum for internally triggered bursts.

8-15-2. SOURce[1|2]:BURSt:STATe

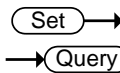

Description	Turns burst mode on or off. By default burst mode is turned off.
Note	When burst mode is turned on, sweep and any modulation modes are disabled.
Syntax	SOURce[1 2]:BURSt:STATe {OFF ON}
Example	SOUR1:BURSt:STAT ON Turns burst mode on.

Query Syntax	SOURce[1 2]:BURSt:STATe?	
Return Parameter	0	Disabled
	1	Enabled
Example	SOUR1:BURSt:STAT? 0 Burst mode is off.	

8-15-3. SOURce[1|2]:BURSt:MODE

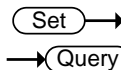

Description	Sets or queries the burst mode as gated or triggered. The default burst mode is triggered.	
Note	The burst count, period, trigger source and any manual trigger commands are ignored in gated burst mode.	
Syntax	SOURce[1 2]:BURSt:MODE {TRIGgered GATed}	
Example	SOUR1:BURSt:MODE TRIG Sets the burst mode to triggered.	
Query Syntax	SOURce[1 2]:BURSt:MODE?	
Return Parameter	TRIG	Triggered mode
	GAT	Gated mode
Example	SOUR1:BURSt:MODE? TRIG The current burst mode is triggered.	

8-15-4. SOURce[1|2]:BURSt:NCYCles

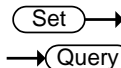

Description	Sets or queries the number of cycles (burst count) in triggered burst mode. The default number of cycles is 1. The burst count is ignored in gated mode.	
-------------	--	--

Note

If the trigger source is set to immediate, the product of the burst period and waveform frequency must be greater than the burst count:

$$\text{Burst Period} \times \text{Waveform frequency} > \text{burst count}$$

If the burst count is too large, the burst period will automatically be increased and a "Settings conflict" error will be generated.

Only sine and square waves are allowed infinite burst above 25 MHz.

Syntax	SOURce[1 2]:BURSt:NCYCles< # cycles> INFinity MINimum MAXimum}	
Parameter	<# cycles>	1~65535 cycles.
	INFinity	Sets the number to continuous.
	MINimum	Sets the number to minimum allowed.
	MAXimum	Sets the number to maximum allowed.
Example	SOUR1:BURSt:NCYCI INF Sets the number of burst cycles to continuous (infinite).	
Query Syntax	SOURce[1 2]:BURSt:NCYCles? [MINimum MAXimum]	
Return Parameter	<NR3>	Returns the number of cycles.
	INF	INF is returned if the number of cycles is continuous.

Example

SOUR1:BURSt:NCYC?
+1.0000E+02

The burst cycles are set to 100.

8-15-5. SOURce[1|2]:BURSt:INTernal:PERiod

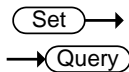

Description

Sets or queries the burst period. Burst period settings are only applicable when the trigger is set to immediate. The default burst period is 10ms.

During manual triggering, external triggering or Gate burst mode, the burst period settings are ignored.

Note The burst period must be long enough to output the designated number of cycles for a selected frequency.
 Burst period > burst count/(waveform frequency + 200 ns)
 If the period is too short, it is automatically increased so that a burst can be continuously output. A “data out of range” error will also be generated.

Syntax	SOURce[1 2]:BURSt:INTernal:PERiod {<seconds> MINimum MAXimum}
Parameter	<seconds > 1 ms ~ 500 seconds
Example	SOUR1:BURS:INT:PER +1.0000E+01 Sets the period to 10 seconds.
Query Syntax	SOURce[1 2]:BURSt:INTernal:PERiod? [MINimum MAXimum]
Return Parameter	<NR3> Returns the burst period in seconds.
Example	SOUR1:BURS:INT:PER? +1.0000E+01 The burst period is 10 seconds.

8-15-6. SOURce[1|2]:BURSt:PHASe

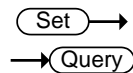

Description	Sets or queries the starting phase for the burst. The default phase is 0 degrees. At 0 degrees, sine square and ramp waveforms are at 0 volts. In gated burst mode, waveforms are continuously output (burst) when the Trig signal is true. The voltage level at the starting phase is used to determine the voltage level of the signal in-between bursts.
Note	The phase command is not used with pulse waveforms.
Syntax	SOURce[1 2]:BURSt:PHASe {<angle> MINimum MAXimum}
Parameter	<angle> -360 ~ 360 degrees
Example	SOUR1:BURS:PHAS MAX Sets the phase to 360 degrees.
Query Syntax	SOURce[1 2]:BURSt:PHASe? [MINimum MAXimum]
Return Parameter	<NR3> Returns the phase angle in degrees.

Example **SOUR1:BURS:PHAS?**
+1.2000E+02
 The burst phase is 120 degrees.

8-15-7. **SOURce[1|2]:BURSt:TRIGger:SOURce**

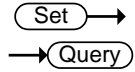

Description Sets or queries the trigger source for triggered burst mode. In triggered burst mode, a waveform burst is output each time a trigger signal is received and the number of cycles is determined by the burst count.

There are three trigger sources for triggered burst mode:

Immediate	A burst is output at a set frequency determined by the burst period.
External	EXTERNAL will output a burst waveform after each external trigger pulse. Any additional trigger pulse signals before the end of the burst are ignored.
Manual	Manual triggering will output a burst waveform after the trigger softkey is pressed.

Note If the APPLy command was used, the source is automatically set to IMMEDIATE.
 The *OPC/*OPC? command/query can be used to signal the end of the burst.

Syntax **SOURce[1|2]:BURSt:TRIGger:SOURce**
{IMMEDIATE|EXTERNAL|MANUAL}

Example **SOUR1:BURS:TRIG:SOUR EXT**
 Sets the burst trigger source to external.

Query Syntax **SOURce[1|2]:BURSt:TRIGger:SOURce?**

Return Parameter	IMM	Immediate
	EXT	External
	MANual	Manual

Example **SOUR1:BURS:TRIG:SOUR?**
IMM
 The burst trigger source is set to immediate.

8-15-8. SOURce[1|2]:BURSt:TRIGger:DELay

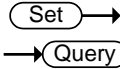

Description	The DELay command is used to insert a delay (in seconds) before a burst is output. The delay starts after a trigger is received. The default delay is 0 seconds.	
Syntax	SOURce[1 2]: BURSt:TRIGger:DELay {<seconds> MINimum MAXimum}	
Parameter	<seconds>	0~655350 nS
Example	SOUR1:BURS:TRIG:DEL +1.0000E+01 Sets the trigger delay to 10 seconds.	
Query Syntax	SOURce[1 2]:BURSt:TRIGger:DELay? [MINimum MAXimum]	
Return Parameter	<NRf>	Delay in seconds
Example	SOUR1:BURS:TRIG:DEL ? +1.0000E+01 The trigger delay is 10 seconds.	

8-15-9. SOURce[1|2]:BURSt:TRIGger:SLOPe

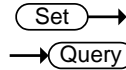

Description	Sets or queries the trigger edge for externally triggered bursts from the Trigger INPUT terminal on the rear panel. By default the trigger is rising edge (Positive).	
Syntax	SOURce[1 2]:BURSt:TRIGger:SLOPe {POSitive NEGative}	
Parameter	POSitive	rising edge
	NEGative	falling edge
Example	SOUR1:BURS:TRIG:SLOP NEG Sets the trigger slope to negative.	
Query Syntax	SOURce[1 2]:BURSt:TRIGger:SLOPe?	
Return Parameter	POS	rising edge
	NEG	falling edge

Example **SOUR1:BURS:TRIG:SLOP ?**
NEG

The trigger slope is negative.

8-15-10. SOURce[1|2]:BURSt:GATE:POLarity

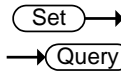

Description In gated mode, the function generator will output a waveform continuously while the external trigger receives logically true signal from the Trigger INPUT terminal. Normally a signal is logically true when it is high. The logical level can be inverted so that a low signal is considered true.

Syntax **SOURce[1|2]:BURSt:GATE:POLarity**
{NORMal|INVertes}

Parameter	NORMal	Logically high
	INVertes	Logically low

Example **SOUR1:BURS:GATE:POL INV**
Sets the state to logically low (inverted).

Query Syntax **SOURce[1|2]:BURSt:GATE:POLarity?**

Return Parameter	NORM	Normal(High) logical level
	INV	Inverted (low) logical level

Example **SOUR1:BURS:GATE:POL?**
INV
The true state is inverted(logically low).

8-15-11. SOURce[1|2]:BURSt:OUTPut:TRIGger:SLOPe

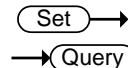

Description Sets or queries the trigger edge of the trigger output signal. The signal is output from the trigger out terminal on the rear panel. The default trigger output slope is positive.

Immediate	50% duty cycle square wave is output at the start of each burst.
-----------	--

External	Trigger output disabled.
----------	--------------------------

Gated mode	Trigger output disabled.
------------	--------------------------

	Manual	A >1 ms pulse is output at the start of each burst.
Syntax	SOURce[1 2]:BURSt:OUTPut:TRIGger:SLOPe {POSitive NEGative}	
Parameter	POSitive	Rising edge.
	NEGative	Falling edge.
Example	SOUR1:BURS:OUTP:TRIG:SLOP POS Sets the trigger output signal slope to positive (rising edge).	
Query Syntax	SOURce[1 2]:BURSt:OUTPut:TRIGger:SLOPe?	
Return Parameter	POS	Rising edge.
	NEG	Falling edge.
Example	SOUR1:BURS:OUTP:TRIG:SLOP? POS The trigger output signal slope to positive.	

8-15-12. OUTPut[1|2]:TRIGger

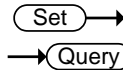

Description	Sets or queries the trigger output signal on or off. By default the signal is disabled. When enabled, a TTL compatible square wave is output.	
Syntax	OUTPut[1 2]:TRIGger {OFF ON}	
Parameter	OFF	Turns the output off.
	ON	Turns the output on.
Example	OUTP1:TRIG ON Turns the output on.	
Query Syntax	OUTPut[1 2]:TRIGger?	
Return Parameter	0	Disabled
	1	Enabled
Query Example	OUTP1:TRIG? 1 The trigger output is enabled.	

8-15-13. SOURce[1|2]:BURSt:TRIGger:MANual



Description This command is used to manually trigger a burst waveform when the source trigger is set to manual for the selected channel. This command is the equivalent of pressing the trigger soft-key on the front panel for manual triggering.

Syntax **SOURce[1|2]:BURSt:TRIGger:MANual**

Example **SOUR1:BURS:TRIG:MAN**
. Manually triggers the burst waveform.

8-16. Arbitrary Waveform Commands

8-16-1. Arbitrary Waveform Overview

Use the steps below to output an arbitrary waveform over the remote interface.

- | | |
|--|---|
| Output Arbitrary Waveform
↓
Select Waveform Frequency, amplitude and offset
↓
Load Waveform Data
↓
Set Waveform Rate | <ol style="list-style-type: none"> 1. Use the SOURce[1 2]:FUNctIon USER command to output the arbitrary waveform currently selected in memory. 2. Use the APPLy command to select frequency, amplitude and DC offset. Alternatively, the FUNC, FREQ, AMPI, and DCOffs commands can be used. 3. Waveform data (1 to 4096 points per waveform) can be downloaded into volatile memory using the DATA:DAC command. Binary integer or decimal integer values in the range of ± 511 can be used. 4. The waveform rate is the product of the number of points in the waveform and the waveform frequency. |
|--|---|

$$\text{Rate} = \text{Hz} \times \# \text{ points}$$

Range:	Rate:	120MHz
	Frequency:	60MHz
	# points:	1~4096

8-16-2. SOURce[1|2]:FUNCTION USER

Set →

Description	Use the SOURce[1 2]:FUNCTION USER command to output the arbitrary waveform currently selected in memory. The waveform is output with the current frequency, amplitude and offset settings.
Syntax	SOURce[1 2]:FUNCTION USER
Example	SOUR1:FUNC USER Selects and outputs the current waveform in memory.

8-16-3. SOURce[1|2]:DATA:DAC

Set →

Description	The SOURce[1 2]:DATA:DAC command is used to download binary or decimal integer values into memory using the IEEE-488.2 binary block format or as an ordered list of values.
-------------	--

Note

The integer values (± 511) correspond to the maximum and minimum peak amplitudes of the waveform. For instance, for a waveform with an amplitude of 5Vpp (0 offset), the value 511 is the equivalent of 2.5 Volts. If the integer values do not span the full output range, the peak amplitude will be limited.

The IEEE-488.2 binary block format is comprised of three parts:

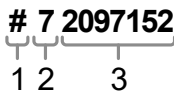

1. Initialization character (#)
2. Digit length (in ASCII) of the number of bytes
3. Number of bytes

IEEE 488.2 uses two bytes to represent waveform data (16 bit integer). Therefore the number of bytes is always twice the number of data points.

Syntax	SOURce[1 2]:DATA:DAC VOLATILE, <start>, {<binary block> <value>, <value>, . . . }
--------	--

Parameter	<start>	Start address of the arbitrary waveform
	<binary block>	
	<value>	Decimal or integer values ± 511

Example **SOUR1:DATA:DAC VOLATILE, #216 Binary Data**

The command above downloads 5 data values (stored in 16 bytes) using the binary block format.

SOUR1:DATA:DAC VOLATILE, 1000, 511, 200, 0, -200, -511

Downloads the data values (511, 200, 0, -200, -511) to address 1000.

8-16-4. SOURce[1|2]:ARB:EDIT:COpy

(Set) →

Description	Copies a segment of a waveform to a specific starting address.	
Syntax	SOURce[1 2]:ARB:EDIT:COpy [<start>[,<length>[,<paste>]]]	
Parameter	<start>	Start address: 0~4095
	<length>	1 ~ 4096
	<paste>	Paste address: 0~4095
Example	SOUR1:ARB:EDIT:COpy 1000, 256, 1257	
	Copies 256 data values starting at address 1000 and copies them to address 1257.	

8-16-5. SOURce[1|2]:ARB:EDIT:DELeTe

(Set) →

Description	Deletes a segment of a waveform from memory. The segment is defined by a starting address and length.	
Note	A waveform/waveform segment cannot be deleted when output.	
Syntax	SOURce[1 2]:ARB:EDIT:DELeTe [<START>[,<LENGTh>]]	
Parameter	<START>	Start address: 0~4095
	<LENGTh>	1 ~ 4096
Example	SOURce1:ARB:EDIT:DEL 1000, 256	
	Deletes a section of 256 data points from the waveform starting at address 1000.	

8-16-4. SOURce[1|2]:ARB:EDIT:DELeTe:ALL

(Set) →

Description	Deletes all user-defined waveforms from non-volatile memory and the current waveform in volatile memory.
Note	A waveform cannot be deleted when output.
Syntax	SOURce[1 2]:ARB:EDIT:DELeTe:ALL
Example	SOUR1:ARB:EDIT:DEL:ALL Deletes all user waveforms from memory.

8-16-7. SOURce[1|2]:ARB:EDIT:POINt

(Set) →

Description	Edit a point on the arbitrary waveform.
Note	A waveform/waveform segment cannot be deleted when output.
Syntax	SOURce[1 2]:ARB:EDIT:POINt [<address> [, <data>]]
Parameter	<address> Address of data point: 0~4095 <data> Value data: ± 511
Example	SOUR1:ARB:EDIT:POIN 1000, 511 Creates a point on the arbitrary waveform at address 1000 with the highest amplitude.

8-16-8. SOURce[1|2]:ARB:EDIT:LINE

(Set) →

Description	Edit a line on the arbitrary waveform. The line is created with a starting address and data point and a finishing address and data point.
Note	A waveform/waveform segment cannot be deleted when output.
Syntax	SOURce[1 2]:ARB:EDIT:LINE [<address1>[,<data1>],[<address2>[,<data2>]]]
Parameter	<address1> Address of data point1: 0~4095 <data1> Value data2: ± 511 <address2> Address of data point2: 0~4095 <data2> Value data2: ± 511

Example **SOUR1:ARB:EDIT:LINE 40, 50, 100, 50**
 Creates a line on the arbitrary waveform at 40,50 to 100,50.

8-16-9. SOURce[1|2]:ARB:EDIT:PROTect

(Set) →

Description Protects a segment of the arbitrary waveform from deletion or editing.

Syntax **SOURce[1|2]:ARB:EDIT:PROTect [<START>[,<LENGth>]**

Parameter	<START>	Start address: 0~4095
	<LENGth>	1 ~ 4096

Example **SOUR1:ARB:EDIT:PROT 40, 50**
 Protects a segment of the waveform from address 40 for 50 data points.

8-16-10. SOURce[1|2]:ARB:EDIT:PROTect:ALL

(Set) →

Description Protects the arbitrary waveform currently in non-volatile memory/ currently being output.

Syntax **SOURce[1|2]:ARB:EDIT:PROTect:ALL**

Example **SOUR1:ARB:EDIT:PROT:ALL**

8-16-11. SOURce[1|2]:ARB:EDIT:UNProtect

(Set) →

Description Uprotects the arbitrary waveform currently in non-volatile memory/currently being output.

Syntax **SOURce[1|2]:ARB:EDIT:UNProtect**

Example **SOUR1:ARB:EDIT:UNP**

8-16-12. SOURce[1|2]:ARB:OUTPut

(Set) →

Description Output the current arbitrary waveform in volatile memory. A specified start and length can also be designated.

Syntax **SOURce[1|2]:ARB:OUTPut [<START>[,<LENGth>]]**

Parameter	<START>	Start address*: 0~4096
	<LENGth>	Length*: 0 ~ 4096
* Start + Length ≤ currently output arbitrary waveform		
Example	SOUR1:ARB:OUTP 20 200	
	Outputs the current arbitrary waveform in memory.	

8-17. COUNTER Commands

The frequency counter function can be turned on remotely to control the frequency counter.

8-17-1. COUNTER:STATE

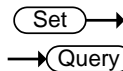

Description	Turns the frequency counter function on or off.	
Syntax	COUNter:STATe {ON OFF}	
Example	COUNter:STATe ON	
	Turns the frequency counter on	
Query Syntax	COUNter:STATe?	
Return Parameter	1	ON
	0	OFF
Example	COUNter:STATe?	
	1	
	Turns on the frequency counter.	

8-17-2. COUNter:GATe

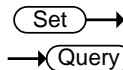

Description	Sets the gate time for the frequency counter.	
Syntax	COUNter:GATe {0.01 0.1 1 10}	
Example	COUNter:GATe 1	
	Sets the gate time to 1S.	
Syntax	COUNter:GATe? {max min}	

Example **COUNTER:GATE?**
 1
 Returns the gate time: 1S.

8-17-3. COUNTER:VALUE?

→ Query

Description	Returns the current value from the frequency counter.
Syntax	COUNTER:VALUE?
Example	COUNTER:VALUE? +5.00E+02 Returns the frequency as 500Hz.

8-18. PHASE Commands

The phase command remotely controls the phase and channel synchronization.

8-18-1. SOURCE[1|2]:PHASE

Set →

→ Query

Description	Sets the phase.	
Syntax	SOURCE[1 2]:PHASE {<phase> <MIN> <MAX>}	
Parameter	phase	-180~180
	min	Sets the phase to the minimum value.
	max	Sets the phase to the maximum value.
Example	SOURCE1:PHASE 25 Sets the phase of channel 1 to 25°.	
Query Syntax	SOURCE[1 2]:PHASE? {MAX MIN}	
Return Parameter	phase	Returns the current phase.
Example	SOURCE1:PHASE? 26 Returns the phase of channel 1 as 26°.	

8-18-2. SOURce[1|2]:PHASe:SYNChronize

Set →

Description	Synchronizes the phase of channel 1 and channel 2. SOURce1 or SOURce2 has not effect on this command.
Syntax	SOURce[1 2]:PHASe:SYNChronize
Example	SOURce1:PHASe:SYNChronize Synchronizes the phase of channel 1 and channel 2.

8-19. COUPLE Commands

The Couple commands can be used to remotely set the frequency coupling and amplitude coupling.

8-19-1.SOURce[1|2]:FREQUency:COUPlE:MODE

Set →
→ Query

Description	Set the frequency coupling mode.
Syntax	SOURce[1 2]:FREQUency:COUPlE:MODE {Off Offset Ratio}
Example	SOURce1:FREQUency:COUPlE:MODE Offset Sets the frequency coupling mode to offset.
Query Syntax	SOURce[1 2]:FREQUency:COUPlE:MODE?
Return Parameter	Off Disables frequency coupling. Offset Set frequency coupling to offset mode. Ratio Sets frequency coupling to ratio mode.
Example	SOURce1:FREQUency:COUPlE:MODE ? Off Frequency coupling is turned off.

8-19-2. SOURce[1|2]:FREQUency:COUPlE:OFFSet

Set →
→ Query

Description	Sets the offset frequency when the frequency coupling mode is set to offset.
Syntax	SOURce[1 2]:FREQUency:COUPlE:OFFSet {frequency}

Example	SOURce1:FREQUENCY:COUple:OFFSet 2khz Sets the offset frequency to 2kHz (the frequency of CH2 minus CH1 is 2kHz).
Syntax	SOURce[1 2]:FREQUENCY:COUple:OFFSet?
Example	SOURce1:FREQUENCY:COUple:OFFSet? +2.0000E+03 The offset of channel 2 from channel 1 is 2kHz.

8-19-3. SOURce[1|2]:FREQUENCY:COUple:RATio

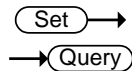

Description	Sets the frequency coupling ratio when frequency coupling is set to ratio mode.
Syntax	SOURce[1 2]:FREQUENCY:COUple:RATio {ratio}
Example	SOURce1:FREQUENCY:COUple:RATio 2 Set the CH2 to CH1 frequency ratio to 2.
Query Syntax	SOURce[1 2]:FREQUENCY:COUple:RATio?
Example	SOURce1:FREQUENCY:COUple:RATio? +2.0000E+00 Returns the CH2 to CH1 frequency ratio as 2.

8-19-4. SOURce[1|2]:AMPlitude:COUple:STATe

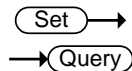

Description	Enables or disables the amplitude coupling.
Syntax	SOURce[1 2]:AMPlitude:COUple:STATe {ON Off}
Example	SOURce1:AMPlitude:COUple:STATe on
Description	Turns amplitude coupling on.
Query Syntax	SOURce[1 2]:AMPlitude:COUple:STATe?
Return Parameter	1 ON 0 Off

Example **SOURce1:AMPLitude:COUPlE:STATe?**
 1
 Amplitude coupling has been enabled.

8-19-5. SOURce[1|2]:TRACk

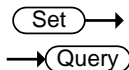

Description Turns tracking on or off.

Syntax **SOURce[1|2]:TRACk {ON|OFF|INVerted}**

Example **SOURce1:TRACk ON**
 Turns tracking on. Channel 2 will “track” the changes of channel 1.

Query Syntax **SOURce[1|2]:TRACk?**

Return Parameter	ON	ON
	OFF	OFF
	INV	INVerted

Example **SOURce1:TRACk?**
 ON
 Channel tracking is turned on.

8-20. Save and Recall Commands

Up to 10 different instrument states can be stored to non-volatile memory (memory locations 0~9).

8-20-1. *SAV

Set →

Description	Saves the current instrument state to a specified save slot. When a state is saved, all the current instrument settings, functions and waveforms are also saved.
Note	The *SAV command doesn't save waveforms in non-volatile memory, only the instrument state. The *RST command will not delete saved instrument states from memory.
Syntax	*SAV {0 1 2 3 4 5 6 7 8 9}
Example	*SAV 0 Save the instrument state to memory location 0.

8-20-2. *RCL

Set →

Description	Recall previously saved instrument states from memory locations 0~9.
Syntax	*RCL {0 1 2 3 4 5 6 7 8 9}
Example	*RCL 0 Recall instrument state from memory location 0.

8-20-3. MEMory:STATe:DELeTe

Set →

Description	Delete memory from a specified memory location.
Syntax	MEMory:STATe:DELeTe {0 1 2 3 4 5 6 7 8 9}
Example	MEM:STAT:DEL 0 Delete instrument state from memory location 0.

8-20-4. MEMory:STATe:DELeTe ALL

Set →

Description	Delete memory from all memory locations, 0~9.
Syntax	MEMory:STATe:DELeTe ALL
Example	MEM:STAT:DEL ALL Deletes all the instrument states from memory locations 0~9.

8-21. Error Messages

The FGX-2220 has a number of specific error codes. Use the `SYSTEM:ERROR` command to recall the error codes. For more information regarding the error queue.

8-21-1.Command Error Codes

-101 Invalid character

An invalid character was used in the command string. Example:
#, \$, %.
`SOURce1:AM:DEPT h MIN%`

-102 Syntax error

Invalid syntax was used in the command string. Example: An unexpected character may have been encountered, like an unexpected space.
`SOURce1:APPL:SQUare , 1`

-103 Invalid separator

An invalid separator was used in the command string. Example: a space, comma or colon was incorrectly used.
`APPL:SIN 1 1000 OR SOURce1:APPL:SQUare`

-108 Parameter not allowed

The command received more parameters than were expected. Example: An extra (not needed) parameter was added to a command
`SOURce1:APPL? 10`

-109 Missing parameter

The command received less parameters than expected. Example: A required parameter was omitted.
`SOURce1:APPL:SQUare .`

-112 Program mnemonic too long

A command header contains more than 12 characters:
`OUTP:SYNCHRONIZATION ON`

-113 Undefined header

An undefined header was encountered. The header is syntactically correct. Example: the header contains a character mistake.
`SOUR1:AMM:DEPT MIN`

-123 Exponent too large

Numeric exponent exceeds 32,000. Example:
`SOURce[1|2]:BURSt:NCYCles 1E34000`

-124 Too many digits

The mantissa (excluding leading 0's) contains more than 255 digits.

-128 Numeric data not allowed

An unexpected numeric character was received in the command. Example: a numeric parameter is used instead of a character string.
`SOURce1:BURSt:MODE 123`

- 131 Invalid suffix
An invalid suffix was used. Example: An unknown or incorrect suffix may have been used with a parameter.
SOURCE1:SWEep:TIME 0.5 SECS
- 138 Suffix not allowed
A suffix was used where none were expected. Example: Using a suffix when not allowed.
SOURCE1:BURSt: NCYCles 12 CYC
- 148 Character data not allowed
A parameter was used in the command where not allowed. Example: A discrete parameter was used where a numeric parameter was expected.
SOURCE1:MARK:FREQ ON
- 158 String data not allowed
An unexpected character string was used where none were expected. Example: A character string is used instead of a valid parameter.
SOURCE1:SWEep:SPACing 'TEN'
- 161 Invalid block data
Invalid block data was received. Example: The number of bytes sent with the DATA:DAC command doesn't correlate to the number of bytes specified in the block header.
- 168 Block data not allowed
Block data was received where block data is not allowed. Example:
SOURCE1:BURSt: NCYCles #10
- 170~178 expression errors
Example: The mathematical expression used was not valid.

8-21-2.Execution Errors

- 211 Trigger ignored
A trigger was received but ignored. Example: Triggers will be ignored until the function that can use a trigger is enabled (burst, sweep, etc.).
- 223 Too much data
Data was received that contained too much data. Example: An arbitrary waveform with over 4096 points cannot be used.
- 221 Settings conflict; turned off infinite burst to allow immediate trigger source
Example: Infinite burst is disabled when an immediate trigger source is selected. Burst count set to 65535 cycles.
- 221 Settings conflict; infinite burst changed trigger source to MANUAL
Example: The trigger source is changed to immediate from manual when infinite burst mode is selected.
- 221 Settings conflict; burst period increased to fit entire burst
Example: The function generator automatically increases the burst period to allow for the burst count or frequency.

- 221 Settings conflict; burst count reduced
Example: The burst count is reduced to allow for the waveform frequency if the burst period is at its maximum.
- 221 Settings conflict; trigger delay reduced to fit entire burst
Example: The trigger delay is reduced to allow the current period and burst count.
- 221 Settings conflict; triggered burst not available for noise
Example: Triggered burst cannot be used with noise.
- 221 Settings conflict; amplitude units changed to Vpp due to high-Z load
Example: If a high impedance load is used, dBm units cannot be used. The units are automatically set to Vpp.
- 221 Settings conflict; trigger output disabled by trigger external
Example: The trigger output terminal is disabled when an external trigger source is selected.
- 221 Settings conflict; trigger output connector used by FSK
Example: The trigger output terminal cannot be used in FSK mode.
- 221 Settings conflict; trigger output connector used by burst gate
Example: The trigger output terminal cannot be used in gated burst mode.
- 221 Settings conflict; trigger output connector used by trigger external
Example: The trigger output connector is disabled when the trigger source is set to external.
- 221 Settings conflict; frequency reduced for pulse function
Example: When the function is changed to pulse, the output frequency is automatically reduced if over range.
- 221 Settings conflict; frequency reduced for ramp function
Example: When the function is changed to ramp, the output frequency is automatically reduced if over range.
- 221 Settings conflict; frequency made compatible with burst mode
Example: When the function is changed to burst, the output frequency is automatically adjusted if over range.
- 221 Settings conflict; frequency made compatible with FM
Example: When the function is changed to FM, the frequency is automatically adjusted to suit the FM settings.
- 221 Settings conflict; burst turned off by selection of other mode or modulation
Example: Burst mode is disabled when sweep or a modulation mode is enabled.
- 221 Settings conflict; FSK turned off by selection of other mode or modulation
Example: FSK mode is disabled when burst, sweep or a modulation mode is enabled.
- 221 Settings conflict; FM turned off by selection of other mode or modulation
Example: FM mode is disabled when burst, sweep or a modulation mode is enabled.
- 221 Settings conflict; AM turned off by selection of other mode or modulation
Example: AM mode is disabled when burst, sweep or a modulation mode is enabled.

- 221 Settings conflict; sweep turned off by selection of other mode or modulation
Example: Sweep mode is disabled when burst or a modulation mode is enabled.
- 221 Settings conflict;not able to modulate this function
Example: A modulated waveform cannot be generated with dc voltage, noise or pulse waveforms.
- 221 Settings conflict;not able to sweep this function
Example: A swept waveform cannot be generated with dc voltage, noise or pulse waveforms.
- 221 Settings conflict;not able to burst this function
Example: A burst waveform cannot be generated with the dc voltage function.
- 221 Settings conflict;not able to modulate noise, modulation turned off
Example: A waveform cannot be modulated using the noise function.
- 221 Settings conflict;not able to sweep pulse, sweep turned off
Example: A waveform cannot be swept using the pulse function.
- 221 Settings conflict;not able to modulate dc, modulation turned off
Example: A waveform cannot be modulated using the dc voltage function.
- 221 Settings conflict;not able to sweep dc, modulation turned off
Example: A waveform cannot be swept using the dc voltage function.
- 221 Settings conflict;not able to burst dc, burst turned off
Example: The burst function cannot be used with the dc voltage function.
- 221 Settings conflict;not able to sweep noise, sweep turned off
Example: A waveform cannot be swept using the noise function.
- 221 Settings conflict;pulse width decreased due to period
Example: The pulse width has been adjusted to suit the period settings.
- 221 Settings conflict;amplitude changed due to function
Example: The amplitude (VRM / dBm) has been adjusted to suit the selected function. For the FGX-2220, a typical square wave has a much higher amplitude (5V Vrms) compared to a sine wave (~3.54) due to crest factor.
- 221 Settings conflict;offset changed on exit from dc function
Example: The offset level is adjusted on exit from a DC function.
- 221 Settings conflict;FM deviation cannot exceed carrier
Example: The deviation cannot be set higher than the carrier frequency
- 221 Settings conflict;FM deviation exceeds max frequency
Example: If the FM deviation and carrier frequency combined exceeds the maximum frequency plus 100 kHz, the deviation is automatically adjusted.
- 221 Settings conflict;frequency forced duty cycle change
Example: If the frequency is changed and the current duty cannot be supported at the new frequency, the duty will be automatically adjusted.

-221 Settings conflict;offset changed due to amplitude

Example: The offset is not a valid offset value, it is automatically adjusted, considering the amplitude.

$$|\text{offset}| \leq \text{max amplitude} - V_{pp}/2$$

-221 Settings conflict;amplitude changed due to offset

Example: The amplitude is not a valid value, it is automatically adjusted, considering the offset.

$$V_{pp} \leq 2X (\text{max amplitude} - |\text{offset}|)$$

-221 Settings conflict;low level changed due to high level

Example: The low level value was set too high. The low level is set 1 mV less than the high level.

-221 Settings conflict;high level changed due to low level

Example: The high level value was set too low. The high level is set 1 mV greater than the low level.

-222 Data out of range;value clipped to upper limit

Example: The parameter was set out of range. The parameter is automatically set to the maximum value allowed.

SOURce[1|2]:FREQuency 25.1MHz.

-222 Data out of range;value clipped to lower limit

Example: The parameter was set out of range. The parameter is automatically set to the minimum value allowed.

SOURce[1|2]:FREQuency 0.1μHz.

-222 Data out of range;period; value clipped to ...

Example: The period was set to a value out of range, it is automatically set to an upper or lower limit.

-222 Data out of range;frequency; value clipped to ...

Example: If the frequency was set to a value out of range, it is automatically set to an upper or lower limit.

-222 Data out of range;user frequency; value clipped to upper limit

Example: If the frequency is set to a value out of range for an arbitrary waveform using, SOURce[1|2]: APPL: USER or SOURce[1|2]: FUNC:USER, it is automatically set to the upper limit.

-222 Data out of range;ramp frequency; value clipped to upper limit

Example: If the frequency is set to a value out of range for a ramp waveform using, SOURce[1|2]: APPL: RAMP or SOURce[1|2]:FUNC:RAMP, it is automatically set to the upper limit.

-222 Data out of range;pulse frequency; value clipped to upper limit

Example: If the frequency is set to a value out of range for a pulse waveform using, SOURce[1|2]: APPL:PULS or SOURce[1|2]:FUNC:PULS, it is automatically set to the upper limit.

-222 Data out of range;burst period; value clipped to ...

Example: If the burst period was set to a value out of range, it is automatically set to an upper or lower limit.

222 Data out of range;burst count; value clipped to ...

Example: If the burst count was set to a value out of range, it is automatically set to an upper or lower limit.

-222 Data out of range; burst period limited by length of burst; value clipped to upper limit

Example: The burst period must be greater than burst count divided by the frequency + 200 ns. The burst period is adjusted to satisfy these conditions.

burst period > 200 ns + (burst count/burst frequency).

-222 Data out of range; burst count limited by length of burst; value clipped to lower limit

Example: The burst count must be less than burst period * the waveform frequency when the the trigger source is set to immediate (SOURce[1|2]: TRIG:SOUR IMM). The burst count is automatically set to the lower limit.

-222 Data out of range;amplitude; value clipped to ...

Example: If the amplitude was set to a value out of range, it is automatically set to an upper or lower limit.

-222 Data out of range;offset; value clipped to ...

Example: If the offset was set to a value out of range, it is automatically set to an upper or lower limit.

-222 Data out of range;frequency in burst mode; value clipped to ...

Example: If the frequency was set to a value out of range in burst mode. The burst frequency is automatically set to an upper or lower limit, taking the burst period into account.

-222 Data out of range;frequency in FM; value clipped to ...

Example: The carrier frequency is limited by the frequency deviation (SOURce[1|2]: FM:DEV). The carrier frequency is automatically adjusted to be less than or equal to the frequency deviation.

-222 Data out of range;marker confined to sweep span; value clipped to ...

Example: The marker frequency is set to a value outside the start or stop frequencies. The marker frequency is automatically adjusted to either the start or stop frequency (whichever is closer to the set value).

-222 Data out of range;FM deviation; value clipped to ...

Example: The frequency deviation is outside of range. The deviation is automatically adjusted to an upper or lower limit, depending on the frequency.

-222 Data out of range;trigger delay; value clipped to upper limit

Example: The trigger delay was set to a value out of range. The trigger delay has been adjusted to the maximum (655350 nseconds).

-222 Data out of range; trigger delay limited by length of burst; value clipped to upper limit

Example: The trigger delay and the burst cycle time combined must be less than the burst period.

-222 Data out of range;duty cycle; value clipped to ...

Example: The duty cycle is limited depending on the frequency.

Duty Cycle	Frequency
50%	> 25MHz
10%~90%	100 KHz ~ 1MHz
1%~99%	< 100KHz

-222 Data out of range; duty cycle limited by frequency; value clipped to upper limit

Example: The duty cycle is limited depending on the frequency. When the frequency is greater than 50 MHz, the duty cycle is automatically limited to 50%.

-313 Calibration memory lost;memory corruption detected

Indicates that a fault (check sum error) has occurred with the non-volatile memory that stores the calibration data.

-314 Save/recall memory lost;memory corruption detected

Indicates that a fault (check sum error) has occurred with the non-volatile memory that stores the save/recall files.

-315 Configuration memory lost;memory corruption detected

Indicates that a fault (check sum error) has occurred with the non-volatile memory that stores the configuration settings.

-350 Queue overflow

Indicates that the error queue is full (over 20 messages generated, and not yet read). No more messages will be stored until the queue is empty. The queue can be cleared by reading each message, using the *CLS command or restarting the function generator.

8-21-3.Query Errors

-410 Query INTERRUPTED

Indicates that a command was received but the data in the output buffer from a previous command was lost.

-420 Query UNTERMINATED

The function generator is ready to return data, however there was no data in the output buffer. For example: Using the APPLY command.

-430 Query DEADLOCKED

Indicates that a command generates more data than the output buffer can receive and the input buffer is full. The command will finish execution, though all the data won't be kept.

8-21-4.Arbitrary Waveform Errors

-770 Nonvolatile arb waveform memory corruption detected

Indicates that a fault (check sum error) has occurred with the non-volatile memory that stores the arbitrary waveform data.

-781 Not enough memory to store new arb waveform; bad sectors

	Indicates that a fault (bad sectors) has occurred with the non-volatile memory that stores the arbitrary waveform data. Resulting in not enough memory to store arbitrary data.
-787	Not able to delete the currently selected active arb waveform
	Example: The currently selected waveform is being output and cannot be deleted.
800	Block length must be even
	Example: As block data (DATA:DAC VOLATILE) uses two bytes to store each data point, there must be an even number of bytes for a data block.

8-22. SCPI Status Register

The status registers are used to record and determine the status of the function generator. The function generator has a number of register groups:

- Questionable Status Registers
- Standard Event Status Registers
- Status Byte Register
- As well as the output and error queues.

Each register group is divided into three types of registers: condition registers, event registers and enable registers.

8-22-1. Register types

Condition Register	The condition registers indicate the state of the function generator in real time. The condition registers are not triggered. I.e., the bits in the condition register change in real time with the instrument status. Reading a condition register will not clear it. The condition registers cannot be cleared or set.
Event Register	The Event Registers indicate if an event has been triggered in the condition registers. The event registers are latched and will remain set unless the *CLS command is used. Reading an event register will not clear it.
Enable Register	The Enable register determines which status event(s) are enabled. Any status events that are not enabled are ignored. Enabled events are used to summarize the status of that register group.

8-22-2. FGX-2220 Status System

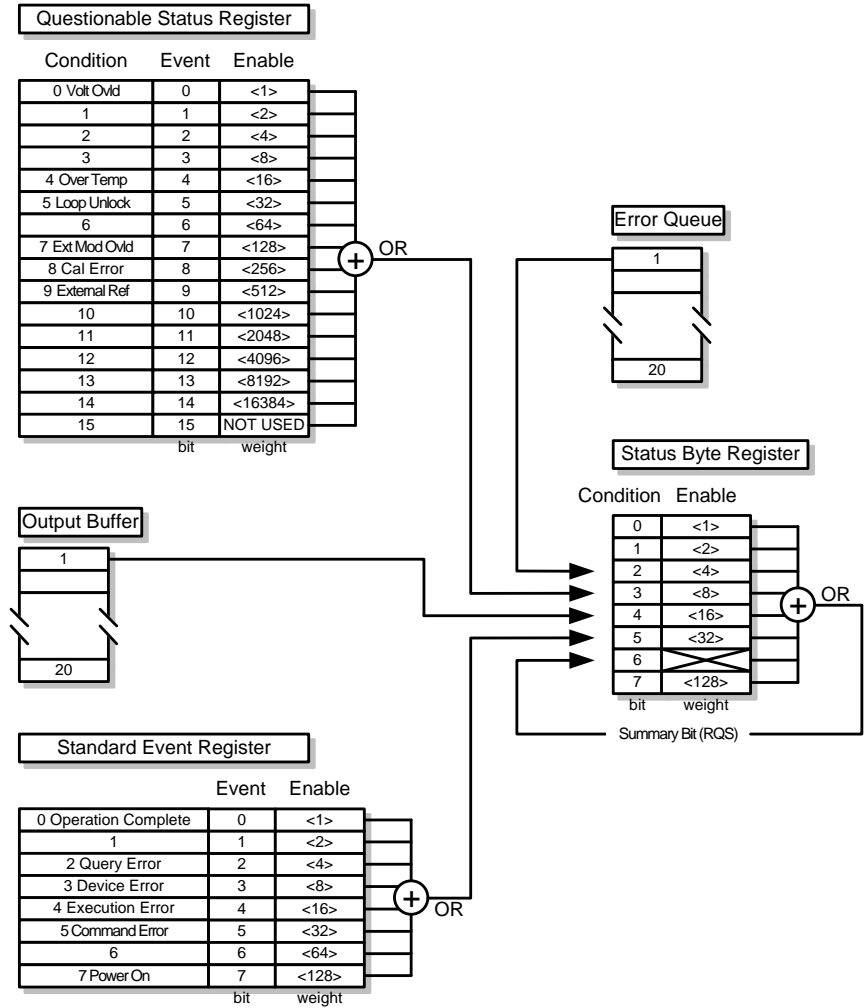

8-22-3. Questionable Status Register

Description	The Questionable Status Registers will show if any faults or errors have occurred.		
Bit Summary	Register	Bit	Bit Weight
	Voltage overload	0	1
	Over temperature	4	16
	Loop unlock	5	32
	Ext Mod Overload	7	128
	Cal Error	8	256
	External Reference	9	512

8-22-4. Standard Event Status Registers

Description	The Standard Event Status Registers indicate when the *OPC command has been executed or whether any programming errors have occurred.	
Notes	<p>The Standard Event Status Enable register is cleared when the *ESE 0 command is used.</p> <p>The Standard Event Status Event register is cleared when the *CLS command or the *ESR? command is used.</p>	
Bit Summary	Register	Bit
	Operation complete bit	0
	Query Error	2
	Device Error	3
	Execution Error	4
	Command Error	5
	Power On	7
Error Bits	Operation complete	The operation complete bit is set when all selected pending operations are complete. This bit is set in response to the *OPC command.
	Query Error	The Query Error bit is set when there is an error reading the Output Queue. This can be caused by trying to read the Output Queue when there is no data present.
	Device Error	The Device Dependent Error indicates a failure of the self-test, calibration, memory or other device dependent error.

Execution Error	The Execution bit indicates an execution error has occurred.
Command Error	The Command Error bit is set when a syntax error has occurred.
Power On	Power has been reset.

8-22-5. The Status Byte Register

Description The Status Byte register consolidates the status events of all the status registers. The Status Byte register can be read with the *STB? query or a serial poll and can be cleared with the *CLS command.

Clearing the events in any of the status registers will clear the corresponding bit in the Status Byte register.

Notes The Status byte enable register is cleared when the *SRE 0 command is used.

The Status Byte Condition register is cleared when the *CLS command is used.

Bit Summary	Register	Bit	Bit Weight
	Error Queue	2	4
	Questionable Data	3	8
	Message Available	4	16
	Standard Event	5	32
	Master Summary / Request Service	6	64

Status Bits	Error Queue	There are error message(s) waiting in the error queue.
	Questionable data	The Questionable bit is set when an “enabled” questionable event has occurred.
	Message Available	The Message Available bit is set when there is outstanding data in the Output Queue. Reading all messages in the output queue will clear the message available bit.
	Standard Event	The Event Status bit is set if an “enabled” event in the Standard Event Status Event Register has occurred.

Master Summary/Service Request bit	The Master Summary Status is used with the *STB? query. When the *STB? query is read the MSS bit is not cleared. The Request Service bit is cleared when it is polled during a serial poll.
------------------------------------	--

8-22-6. Output Queue

Description	The Output queue stores output messages in a FIFO buffer until read. If the Output Queue has data, the MAV bit in the Status Byte Register is set.
-------------	--

8-22-7. Error Queue

Description	<p>The error queue is queried using the SYSTem:ERRor? command. The Error queue will set the “Error Queue” bit in the status byte register if there are any error messages in the error queue. If the error queue is full the last message will generate a “Queue overflow” error and additional errors will not be stored. If the error queue is empty, “No error” will be returned.</p> <p>Error messages are stored in the error queue in a first-in-first-out order. The errors messages are character strings that can contain up to 255 characters.</p>
-------------	--

9. APPDENIX

9-1. FGX-2220 Specifications

The specifications apply when the function generator is powered on for at least 30 minutes under +18°C~+28°C.

FGX-2220 models		
Waveforms	Sine, Square, Ramp, Pulse, Noise, ARB	
Arbitrary Functions		
	Sample Rate	120 MSa/s
	Repetition Rate	60MHz
	Waveform Length	4k points
	Amplitude Resolution	10 bits
	Non-Volatile Memory	4k points
Frequency Characteristics		
Range	Sine	1uHz~25MHz
	Square	1uHz~25MHz
	Ramp	1MHz
Resolution	1uHz	
Accuracy	Stability	±20 ppm
	Aging	±1 ppm, per 1 year
	Tolerance	≤1 mHz
Output Characteristics		
Amplitude	Range	1mVpp to 10 Vpp (into 50Ω) 2mVpp to 20 Vpp (open-circuit) 1mVpp to 5 Vpp (into 50Ω) for 20MHz-25MHz 2mVpp to 10 Vpp (open-circuit) for 20MHz-25MHz
	Accuracy	±2% of setting ±1 mVpp (at 1 kHz, Sin wave, into 50Ω, Offset:0V)
	Resolution	1mV or 3 digits
	Flatness	±1% (0.1dB) ≤100kHz ±3% (0.3 dB) ≤5MHz ±5% (0.4 dB) ≤12MHz ±10%(0.9dB) ≤25MHz (sine wave relative to 1kHz,into50Ω)
	Units	Vpp, Vrms, dBm
Offset	Range	±5 Vpk ac +dc (into 50Ω) ±10Vpk ac +dc (Open circuit) ±2.5 Vpk ac +dc (into 50Ω) for 20MHz-25MHz ±5Vpk ac +dc (Open circuit) for 20MHz-25MHz
	Accuracy	2% of setting + 20mV+ 0.5% of amplitude
Waveform Output	Impedance	50Ω typical (fixed) > 10MΩ (output disabled)

	Protection	Short-circuit protected Overload relay automatically disables main output	
Sine wave Characteristics			
	Harmonic distortion	≤ -55 dBc DC ~ 200kHz, ≤ -50 dBc 200kHz ~ 1MHz, ≤ -35 dBc 1MHz ~ 5MHz, ≤ -30 dBc 5MHz ~ 25MHz,	Ampl > 0.1Vpp Ampl > 0.1Vpp Ampl > 0.1Vpp Ampl > 0.1Vpp
Square wave Characteristics			
	Rise/Fall Time	≤ 25 ns at maximum output. (into 50 Ω load)	
	Overshoot	5%	
	Asymmetry	1% of period +5 ns	
	Variable duty Cycle	1.0% to 99.0% ≤ 100 kHz	
		10% to 90% ≤ 1 MHz	
		50% ≤ 25 MHz	
Ramp Characteristics			
	Linearity	< 0.1% of peak output	
	Variable Symmetry	0% to 100% (0.1% Resolution)	
Pulse Characteristics			
	Period	40ns~2000s	
	Pulse Width	20ns~1999.9s	
	Overshoot	<5%	
	Jitter	20ppm +10ns	
AM Modulation			
	Carrier Waveforms	Sine, Square, Ramp, Pulse, Arb	
	Modulating Waveforms	Sine, Square, Triangle, Upramp, Dnramp	
	Modulating Frequency	2mHz to 20kHz (Int), DC to 20kHz (Ext)	
	Depth	0% to 120.0%	
	Source	Internal / External	
FM Modulation			
	Carrier Waveforms	Sine, Square, Ramp,	
	Modulating Waveforms	Sine, Square, Triangle, Upramp, Dnramp	
	Modulating Frequency	2mHz to 20kHz (Int), DC to 20kHz (Ext)	
	Peak Deviation	DC to Max Frequency	
	Source	Internal / External	
Sweep			
	Waveforms	Sine, Square, Ramp,	
	Type	Linear or Logarithmic	
	Start/Stop Freq	1uHz to Max Frequency	

	Sweep Time	1ms to 500s
	Source	Internal / External/Manual
FSK		
	Carrier Waveforms	Sine, Square, Ramp,Pulse
	Modulating Waveforms	50% duty cycle square
	Modulation Rate	2mHz to 100 kHz (INT) ,DC to 100 kHz(EXT)
	Frequency Range	1uHz to Max Frequency
	Source	Internal / External
PM		
	Carrier Waveforms	Sine, Square, Ramp
	Modulating Waveforms	Sine, Square, Triangle,Upramp, Dnramp
	Modulation Frequency	2mHz to 20kHz (Int),DC to 20kHz (Ext)
	Phase deviation	0° to 360°
	Source	Internal / External
SUM		
	Carrier Waveforms	Sine, Square, Ramp,Pulse,Noise
	Modulating Waveforms	Sine, Square, Triangle,Upramp,Dnramp
	Modulation Frequency	2mHz to 20kHz (Int),DC to 20kHz (Ext)
	SUM Depth	0% to 100.0%
	Source	Internal / External
External Trigger Input		
	Type	For FSK, Burst, Sweep
	Input Level	TTL Compatibility
	Slope	Rising or Falling(Selectable)
	Pulse Width	>100ns
	Input Impedance	10kΩ, DC coupled
External Modulation Input		
	Type	For AM, FM, PM, SUM
	Voltage Range	±5V full scale
	Input Impedance	10kΩ
	Frequency	DC to 20kHz
Trigger Output		
	Type	For Burst, Sweep, Arb
	Level	TTL Compatible into 50Ω
	Pulse Width	>450ns
	Maximum Rate	1MHz
	Fan-out	≥4 TTL Load
	Impedance	50Ω Typical

Dual Channel Function	CH1	CH2
Phase	-180° ~180°	-180° ~ 180°
	Synchronize phase	Synchronize phase
Track	CH2=CH1	CH1=CH2
Coupling	Frequency(Ratio or Difference)	Frequency(Ratio or Difference)
	Amplitude & DC Offset	Amplitude & DC Offset
Dsotlink	√	√
Burst	Waveforms	Sine, Square, Ramp
	Frequency	1uHz~25MHz
	Burst Count	1 to 65535 cycles or Infinite
	Start/Stop Phase	-360 to +360
	Internal Period	1ms to 500s
	Gate Source	External Trigger
	Trigger Source	Single, External or Internal Rate
Trigger Delay	N-Cycle, Infinite	0s to 655350ns
Frequency Counter	Range	5Hz to 150MHz
	Accuracy	Time Base accuracy±1count
	Time Base	±20ppm (23°C ±5°C) after 30 minutes warm up
	Resolution	The maximum resolution is: 100nHz for 1Hz, 0.1Hz for 100MHz.
	Input Impedance	1kΩ/1pf
	Sensitivity	35mVrms ~ 30Vms (5Hz to 150MHz)
Save/Recall		10 Groups of Setting Memories
Interface		USB (Host&Device)
Display		TFT (320 x 240 dots)
General Specifications	Power Source	AC100~240V, 50~60Hz, ±10%
	Power	25 W (Max)
	Consumption	
	Operating Environment	Temperature to satisfy the specification : 18 ~ 28°C Operating temperature :0 ~ 40°C Relative Humidity: < 80%, 0 ~ 40°C Installation category : CAT II
	Operating Altitude	2000 Meters, Indoor
	Storage Temperature	-10~70°C, Humidity: ≤70%
	Dimensions	266(W) x 107(H) x 293(D) mm
	Weight	Approx. 2.5kg
	Accessories	GTL-101x 2 Power cordx1

9-2. External Dimensions Figure

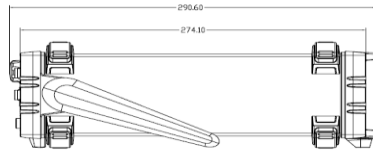
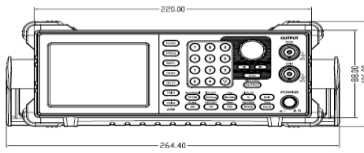
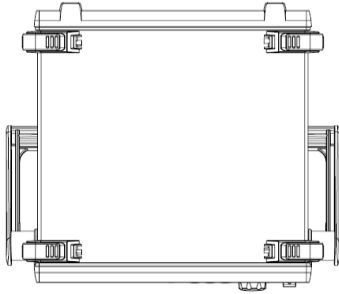

9-3. Usage Notes for FGX-2220

At the time of change of the setting by hand operation and external controls in this instrument, the waiting time in the following table until the next control and the next operation is enabled is required.

If you want a continuous set and query, please put the weights.

Panel	Command	Setting	Wait time(typ)
Preset Recall	SOUR[1 2]:APPL	Apply	1500ms
Waveform ARB	SOUR[1 2]:FUNC	Function	500ms
FREQ	SOUR[1 2]:FREQ	Frequency	200ms
AMPL	SOUR[1 2]:AMP	Amplitude	100ms
Offset	SOUR[1 2]:DCO	DC Offset	100ms
OUTPUT	OUTP[1 2]	OUTPUT ON/OFF	100ms
MOD	SOUR[1 2]:AM SOUR[1 2]:FM SOUR[1 2]:FSK SOUR[1 2]:PM SOUR[1 2]:SUM	Modulation	1000ms
Sweep	SOUR[1 2]:SWE	Sweep mode	1000ms
Burst	SOUR[1 2]:BURS	Burst mode	1000ms
INT/EXT	SOUR[1 2]:*:SOUR	Input modulation	200ms
Other	Setting Commands	Other setting	100ms
	Common Commands	SCPI command	0ms



TEXIO TECHNOLOGY CORPORATION

7F Towa Fudosan Shin Yokohama Bldg.
2-18-7, Shin Yokohama, Kohoku-ku, Yokohama, Kanagawa, 222-0033 Japan
<https://www.texio.co.jp/>
